

# JMS Furniture

proudly manufactured in New Jersey

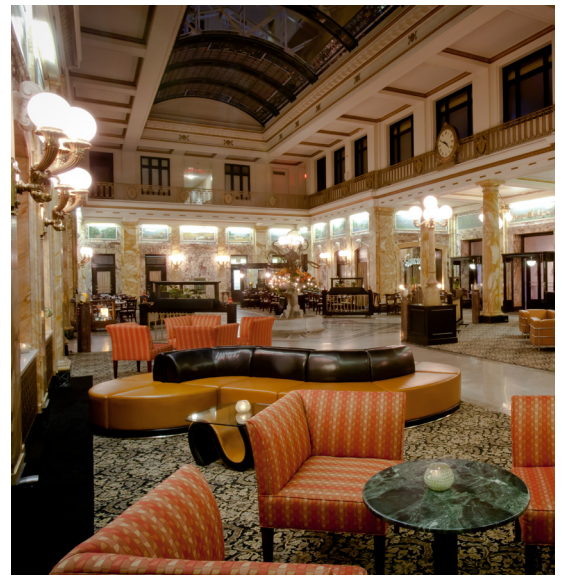

[www.JMSfurniture.com](http://www.JMSfurniture.com)

954 - 270 - 9488

# JMS Furniture

proudly manufactured in New Jersey

JMS-Furniture plans, designs, manufactures and delivers high-performance commercial furniture products.

Our craftsmen specialize in working with wood, metal, vinyl, leather, fabric, laminates, HDPE marine plastic and customer own materials.

We are your one-stop-shop solution. We can create anything to your specs, and we are committed to meet any deadline. We are your source for reliable, unique and high quality commercial furniture.



[www.JMSfurnituresales.com](http://www.JMSfurnituresales.com)

954 - 270 - 9488



## Model: JMS-FORTUNA

Fortuna is our answer to unique spaces that require a modern appeal with an efficient and very flexible seating that can be arranged at will to create a new and exciting seating.

Upholstery is Classic Super Performance:

- The fabrics are handcrafted to withstand the rigorous demands of commercial interiors within restaurants, nightclubs, education, hospitality, corporate, and healthcare environments.
- How it feels: soft and supple hand with a true leather-pattern and texture. Performance specifications: Abrasion resistance contract-grade 500,000 double rubs. Enhanced stain resistance with a liquid barrier.
- Environmentally friendly: Phthalate Free, BPA Free, Formaldehyde Free and Lead Free. Fully compliant with all major flammability requirements such California TB 117, NFPA 260 and FMVSS 302.
- Care & Cleaning: Prompt cleaning is always recommended. Clean the soiled area with mild soap and water, then rinse with fresh water and wipe down with a clean cloth.
- Common applications id in hospitality, healthcare, contract, education, marine and automotive industries.

Components:

24" Armless Chair: L 24" | D 25" | H 38 | Seating Depth 19" | Seating Height 18"

36" Armless Chair: L 36" | D 25" | H 38 | Seating Depth 19" | Seating Height 18"

Curved Chaise: L 61" | D 30" | H 38 | Seating Depth 19" | Seating Height 18"



Quick Ship - 9049 Armless Chair



- Length 21"
- Depth 25.5"
- Height 31"
- Seating Depth 21"
- Seating Height 18"

Quick Ship - 9049 Lounge Seating - Corner



- Length 25.5"
- Depth 25.5"
- Height 31"
- Seating Depth 21"
- Seating Height 18"

Quick Ship - 9049 Modular Love Seat



- Length 42"
- Depth 25.5"
- Height 31"
- Seating Depth 21"
- Seating Height 18"



**Model: JMS-9049Z**

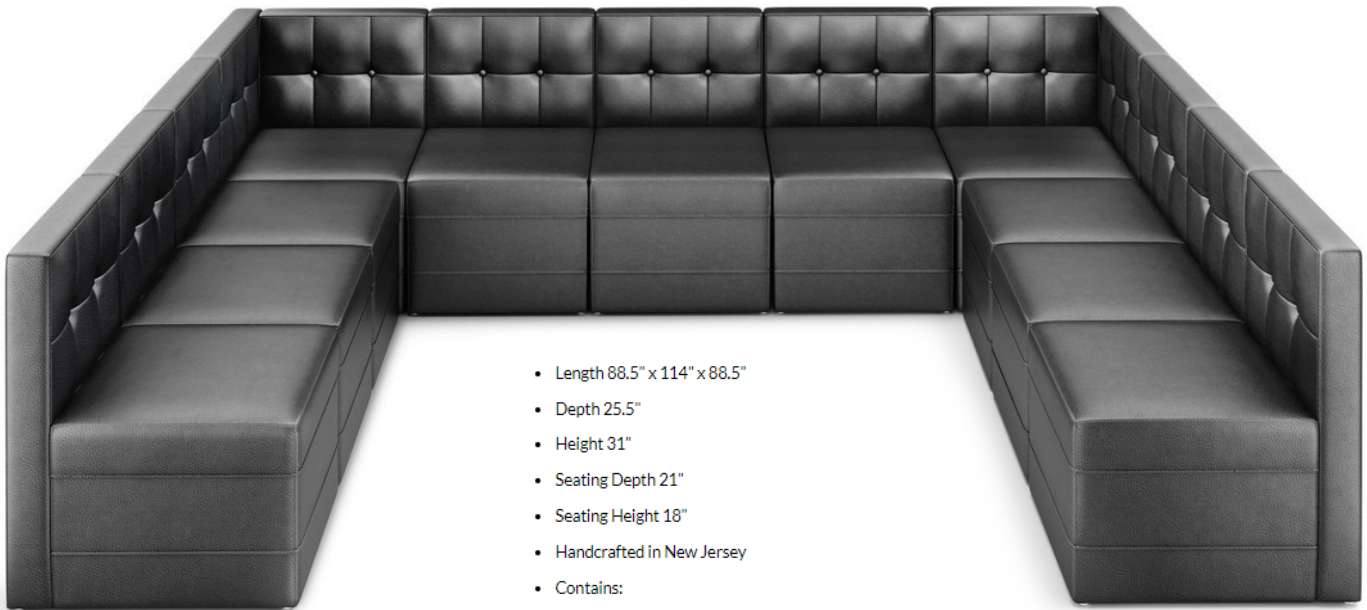

- Length 88.5" x 114" x 88.5"
- Depth 25.5"
- Height 31"
- Seating Depth 21"
- Seating Height 18"
- Handcrafted in New Jersey
- Contains:
  - [2] 9049Z Corner Components
  - [9] 9049Z Armless Chair Components

Quick Ship - 9050Z Armless Chair



- Length 21"
- Depth 25.5"
- Height 52"
- Seating Depth 21"
- Seating Height 18"

Quick Ship - 9050Z Corner



- Length 25.5"
- Depth 25.5"
- Height 52"
- Seating Depth 21"
- Seating Height 18"

Quick Ship - 9050Z Loveseat



- Length 42"
- Depth 25.5"
- Height 52"
- Seating Depth 21"
- Seating Height 18"

Quick Ship - 9050Z Double Loveseat



- Length 42"
- Depth 25.5"
- Height 52"
- Seating Depth 21"
- Seating Height 18"



**Model: JMS-9050Z**

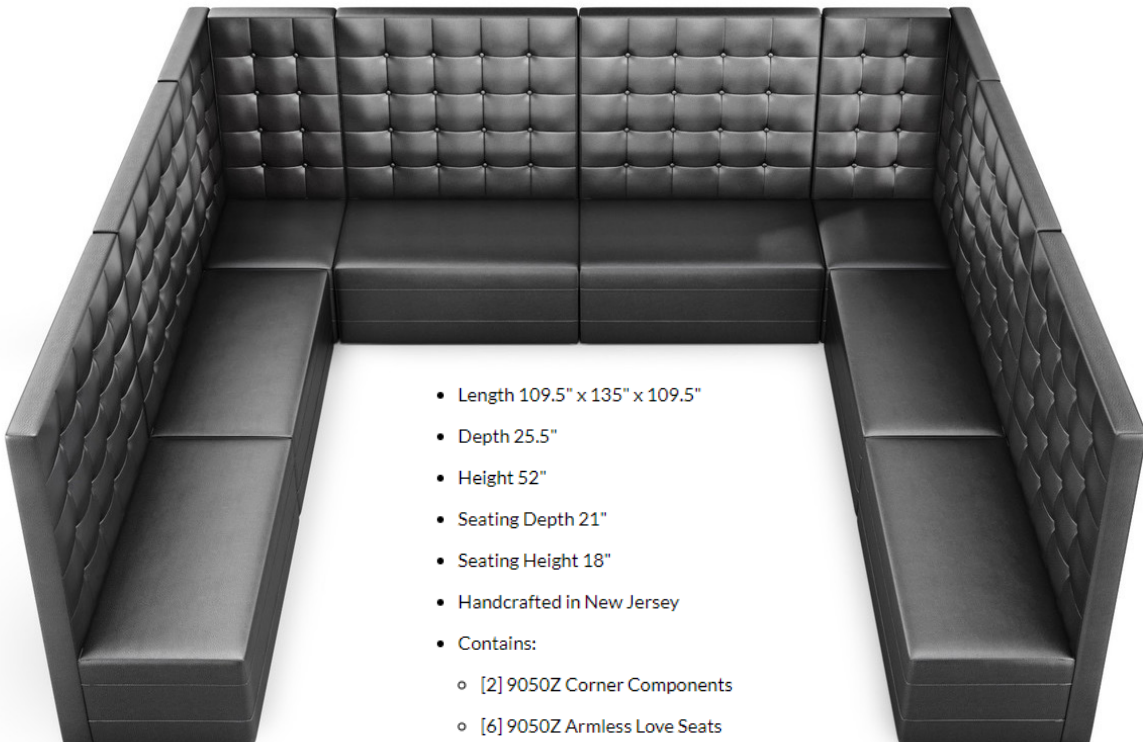

- Length 109.5" x 135" x 109.5"
- Depth 25.5"
- Height 52"
- Seating Depth 21"
- Seating Height 18"
- Handcrafted in New Jersey
- Contains:
  - [2] 9050Z Corner Components
  - [6] 9050Z Armless Love Seats

COCO - Modular Component - Armless Chair



COCO - Modular Component - Corner



COCO - Modular Seating Arrangement G1



Armless Chair (Extension): Length 27" | Width 29" | Height 31" | Seating Depth 20.5" | Seating Height 17.5"

Corner: Length 29" | Width 29" | Height 31" | Seating Depth 20.5" | Seating Height 17.5"

- The 21" depth seating surface allows for ample seating space and comfort. This product was designed to occupy the least amount of space while providing the maximum amount of seating.
- Built to be both lightweight and sturdy, pieces can be transported with ease and used in high traffic areas.
- Frame is built of solid hardwood. Cushion is made of high density CAL 117 certified foam. Joints are glued, stapled and screwed to ensure frame stability and longevity.
- Base sits on metal base glides
- When combined with other modular components, pieces can be re-arranged to suit different applications and offer various layout options



## Model: JMS-COCO



- Dimensions:
  - Armless Chair (Extension): Length 27" | Width 29" | Height 31" | Seating Depth 20.5" | Seating Height 17.5"
  - Ottoman: Length 29" | Width 29" | Height 17.5"
  - Overall Dimensions: Length 139" | Width 58"
- Contains:
  - (6) Coco Armless Chair Component
  - (4) Coco Ottomans

Modular Armless Chair - Inside Wedge



Modular Armless Chair - Outside Wedge



Universal Side Arm



Large Wedge Ottoman



Small Wedge Ottoman



Slice Ottoman



**Model: JMS-HARMONY**



Harmony collection brings the elegance of curved modular components to create beautiful and very unique seating configurations that will give your establishment or event an exclusive modern design.



Overall Length: 182" by 57"

- Contains:
  - [3] Harmony Armless Chair Outside Wedge Component
  - [3] Harmony Armless Chair Inside Wedge Component
  - [1] Harmony Small Wedge Coffee Table 1" Top
  - [1] Left Side Arm
  - [1] Right Side Arm

Quick Ship Ready - 9049X Armless Chair



Quick Ship Ready - 9049X Corner



Quick Ship Ready - 9049X Love Seat



Armless Chair (Extension): Length 21" | Depth 25.5" | Height 31" | Seating Depth 21" | Seating Height 18"

Corner Component: Length 25.5" | Depth 25.5" | Height 31" | Seating Depth 21" | Seating Height 18"

- Modern modular design with a button-tufted upholstery will give your establishment or event an exclusive and an impressive modern appeal
- Upholstery:
  - Commercial-grade vinyl with an abrasion resistance of 500,000 double rubs.
  - Phthalate free and Lead free. It is California TB 117 fire code certified.
  - Common applications in hospitality, healthcare, contract, education, marine and automotive industries.
- The 21" depth seating surface allows for ample seating space and comfort. This product was designed to occupy the least amount of space while providing the maximum amount of seating.



## Model: JMS-9049X



- Dimensions:
  - Corner Component: Length 25.5" | Depth 25.5" | Height 31" | Seating Depth 21" | Seating Height 18"
  - Armless Chair (Extension): Length 21" | Depth 25.5" | Height 31" | Seating Depth 21" | Seating Height 18"
  - Overall length: 88.5" x 114" x 88.5"
- Contains:
  - (2) 9049X Corner Components
  - (9) 9049X Armless Chair Components



Quick Ship Ready - 9050X Armless Chair



Quick Ship Ready - 9050X Modular Corner



Quick Ship Ready - 9050X Love Seat



Armless Chair (Extension): Length 21" | Depth 25.5" | Height 31" | Seating Depth 21" | Seating Height 18"

Corner Component: Length 25.5" | Depth 25.5" | Height 31" | Seating Depth 21" | Seating Height 18"

**Upholstery:**

- Commercial-grade vinyl with an abrasion resistance of 500,000 double rubs.
- Phthalate free and Lead free. It is California TB 117 fire code certified.
- Common applications in hospitality, healthcare, contract, education, marine and automotive industries.



**Model: JMS-9050X**

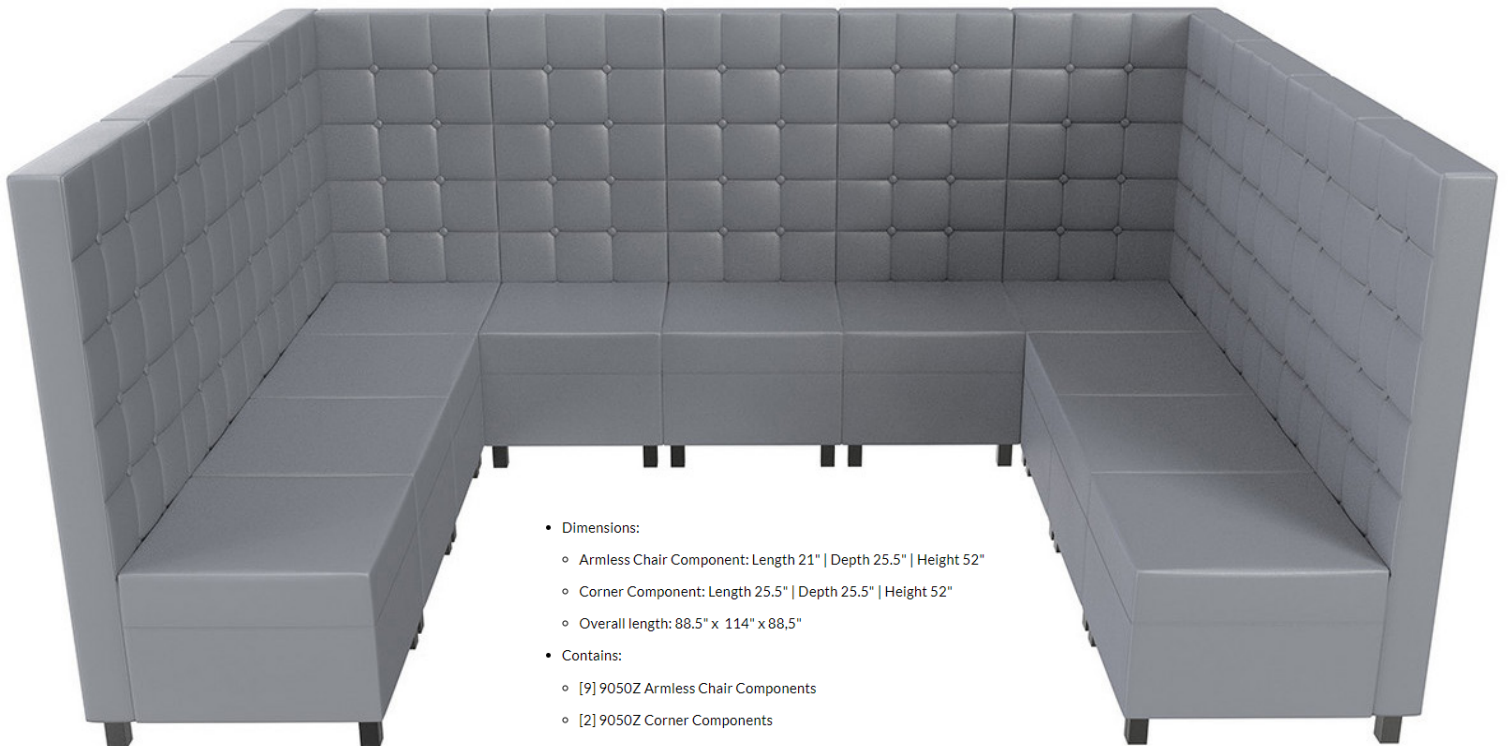

- Dimensions:
  - Armless Chair Component: Length 21" | Depth 25.5" | Height 52"
  - Corner Component: Length 25.5" | Depth 25.5" | Height 52"
  - Overall length: 88.5" x 114" x 88.5"
- Contains:
  - [9] 9050Z Armless Chair Components
  - [2] 9050Z Corner Components

RIVERA Lounge Seating - Armless Chair



RIVERA Lounge Seating - Corner



RIVERA Lounge Seating - Left Side Component



RIVERA Lounge Seating - Right Side



RIVERA - Loveseat with Straight Arms



RIVERA - Loveseat with Rounded Arms



## Model: JMS-RIVERA



- Dimensions:
  - Left/Right Side: Length 39" | Width 29" | Height 31" | Seating Depth 20.5" | Seating Height 17.5"
  - Armless Chair (Extension): Length 27" | Width 29" | Height 31" | Seating Depth 20.5" | Seating Height 17.5"
  - Overall Dimensions: Length 122" x Width 122"
- Contains:
  - (1) Rivera Left Side Component
  - (1) Rivera Right Side Component
  - (1) Rivera Corner Component
  - (4) Rivera Armless Chairs (Extension)

Square Corner



27" Armless Extension



48" Armless Extension



Rounded Corner



Left / Right Side



Ottoman



Lugano is a modern modular collection, which is well tailored for superb comfort. Lugano collection provides perfect contemporary seating solutions for public spaces in your high traffic environment.

o Classic Super Performance:

- A supple leather grain with Resilience-TM protection.
- Super high-performance commercial grade-vinyl features an abrasion resistance of 500,000 double rubs, which is approximately 5-10 times more than any chair on the market.
- The Classic Super Performance vinyl is also Phthalate free and Lead free. It is California TB 117 fire code certified.

**Model: JMS-LUGANO-Z**



- Width: 75" x 102" x 75"
- Depth: 27"
- Height: 28"
- Seating Height 17.5"
- Seating Depth: 21"
- Each Arm: 6"
- Listing is for
  - [3] 48" Lugano-EXT
  - [2] 27' Lugano-CR

LUGANO - Left Side Modular Component



- Width: 48"
- Depth: 27"
- Height: 28"

LUGANO - Right Side Modular Component



- Width: 48"
- Depth: 27"
- Height: 28"

LUGANO - Corner Modular Component



- Width: 27"
- Depth: 27"
- Height: 28"

LUGANO - Armless Extension



- Width: 48" or 60"
- Depth: 27"
- Height: 28"

LUGANO - Ottoman



- Length: 27", 48", 60" or 73"
- Depth: 27"
- Height: 18"

Lugano is a modern modular collection, which is well tailored for superb comfort. Lugano collection provides perfect contemporary solutions for public spaces in your high traffic environment.

**Model: JMS-LUGANO-X**

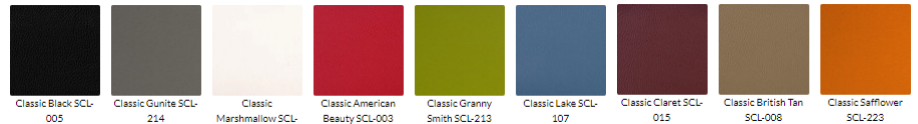

- Overall Dimensions:
  - length: 75" x 102" x 75"
  - Depth: 27"
  - Height: 28"
  - Seating Height 18"
  - Seating Depth: 24"
  - Back Thickness: 6"
- Contains:
  - [3] Lugano 48" Extension Components
  - [2] Lugano Corner Components

Modular Left-Side Component



Modular Right-Side Component



Modular Corner Component



Modular Extension Component



Sofa



Chair



Length: 52" or 73"

Length: 36"

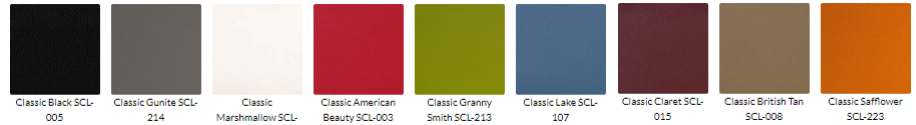

**Model: JMS-HST002**

- HST002 is a modern urban modular collection, which is well tailored for superb comfort. HST002 collection provides perfect contemporary seating solutions for public spaces in your high traffic environment.
- Carbon steel frame is fully welded with a gunmetal powder coated finish.



- Left/ Right component:
  - Width: 47"
  - Depth: 27"
  - Height: 30"
  - Seating Height 17"
  - Seating Depth: 23"
  - Cushion Thickness: 3"
- Extension component
  - Width: 42"
  - Depth: 27"
  - Height: 30"
  - Seating Height 17"
  - Seating Depth: 23"
  - Cushion Thickness: 3"
- Corner component:
  - Width: 27"
  - Depth: 27"
  - Height: 30"
  - Seating Height 17"
  - Seating Depth: 23"
  - Cushion Thickness: 3"

Extension Component  
 Premium Channel Tufted



Extension Component  
 Premium Diamond Tufted



Extension Component  
 Premium Button Tufted



Left/Right Side  
 Premium Channel Tufted



Left/Right Side  
 Premium Diamond Tufted



Left/Right Side  
 Premium Button Tufted



**Model: JMS-LEGACY MODULAR**

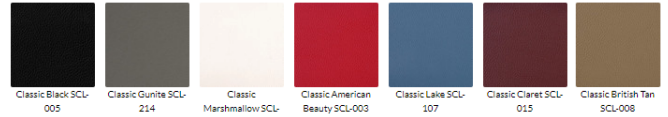

- An exclusive banquette modular extension with a beautiful modern design.
- Exclusive space efficient design which allows you to capitalize on your available space while providing the most seating capacity.
- Built to be sturdy, pieces can be transported with ease and used in high traffic areas
- Upholstered banquette seating with deep soft cushioned padding for the most comfort and support

◦ Extension Components:

- Length 48"
- Width 22"
- Height 42"
- Seating Depth 19"
- Seating Height 18"

◦ Left / Right Side Component:

- Length 70"
- Width 22"
- Height 42"
- Seating Depth 19"
- Seating Height 18"

◦ Overall length: 118" x 140"

• Listing is for

- [4] Legacy Diamond Extensions
- [1] Legacy Diamond Left Side
- [1] Legacy Diamond Right Side

Armless Bench / Extension  
 Flat Back



Armless Bench / Extension  
 Channel Back



Armless Bench / Extension  
 Diamond Back



Corner  
 Flat Back



Corner  
 Channel Back



Corner  
 Diamond Back



- Upholstery is commercial grade vinyl with abrasive resistance starting from 500,000 double rubs. CAL 117 certified and designed specifically for applications in hospitality, contract, health care and education industries
- Frame is built of solid hardwood. Cushion is made of high density CAL 117 certified foam. Joints are glued, stapled and screwed to ensure frame stability and longevity.
- Base sits on elegant 7" wooden legs.

**Model: JMS-NORWAY**

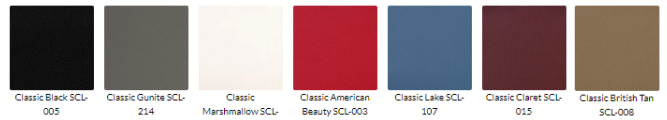

- Dimensions:
  - Armless Extension Length 48" | Depth 24.5"
  - Corner Length 24.5" | Depth 24.5"
  - Overall Length: 73.5" x 97" x 73.5"
  - Overall Height: 36" or 42"
- Components:
  - [3] Armless Extensions
  - [2] Corners

8005 Left-Sided Curved Chaise



8005 Right-Sided Curved Chaise



8005 Curved Extension



8005 Open Back Curved Chaise



**Model: JMS-8005**

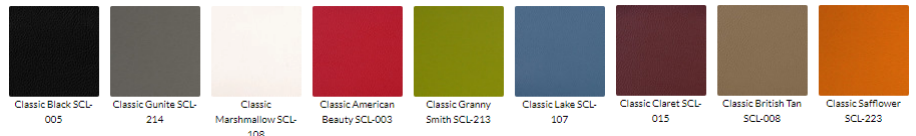

- Dimensions:
  - Left-Sided Chaise: Length 77" | Width 34" | Height 31" | Seating Depth 26" | Seating Height 17"
  - Extension Component: Length 70" | Width 34" | Height 31" | Seating Depth 26" | Seating Height 17"
  - Right-Sided Chaise: Length 77" | Width 34" | Height 31" | Seating Depth 26" | Seating Height 17"
- Contains:
  - (1) 8005 Left Chaise Component - Part #1
  - (1) 8005 Extension Component - Part #2
  - (1) 8005 Right Chaise Component - Part #Right



Armless Chair (27")



Armless Chair (46")



Armless Chair (66"/ 84")



Left Side



Right Side



Corner



**Model: JMS-ESCAPE**



- Contains:
  - [2] Escape 46" Extensions: Length 46" | Width 29" | Height 31" | Seating Depth 20.5" | Seating Height 17.5"
  - [1] Escape Corner Component: Length 29" | Width 29" | Height 31" | Seating Depth
  - [1] Escape Left Side Component: Length 34" | Width 29" | Height 31" | Seating Depth 20.5" | Seating Height 17.5"
  - [1] Escape Right Side Component: Length 34" | Width 29" | Height 31" | Seating Depth 20.5" | Seating Height 17.5"
  - Overall Length: 111.5" x 111.5"

Left Side



Right Side



Corner



Extension



144" Long Sofa



**Model: JMS-LEON-Z**

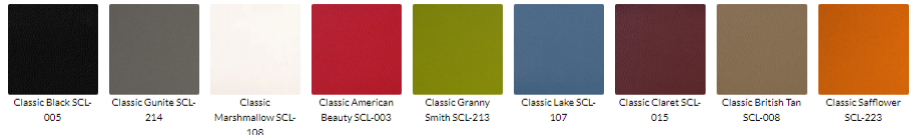

- Contains:
  - [1] Leon-Z Left Side Component
  - [1] Leon-Z Right Side Component
  - [1] Leon-Z Extension Component

27" Extension - Flat Back



27" Extension - Diamond Back



27" Extension - Button Back



Corner Component



48" Extension - Flat Back



48" Extension - Diamond Back



48" Extension - Button Back



**Model: JMS-STYLE-M**

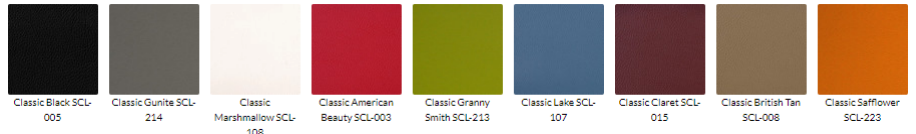

- Dimensions:
  - Overall length: 102" x 102"
  - Depth 27"
  - Height 36"
  - Seating Height 18"
  - Seating Depth 21"
- Contains
  - [3] Style-M Modular Corner Components
  - [2] Style-M Modular 48" Extension Components

Armless Chair



- o Overall Length: 19
- o Overall Depth: 25"
- o Overall Height: 44"
- o Seating Depth: 18.5"
- o Seating Height: 17.5"

Corner



- o Overall Length: 25
- o Overall Depth: 25"
- o Overall Height: 44"
- o Seating Depth: 18.5"
- o Seating Height: 17.5"

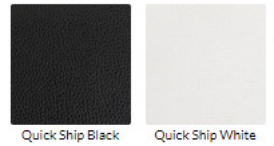

**Model: JMS-1926**



- o Overall Length: 82" x 107" x 82"
- o Overall Depth: 25"
- o Overall Height: 44"
- o Seating Depth: 18.5"
- o Seating Height: 17.5"
- o Components:
  - o [4] 1926 Corners
  - o [9] 1926 Armless Chairs



**Model: JMS-8006**

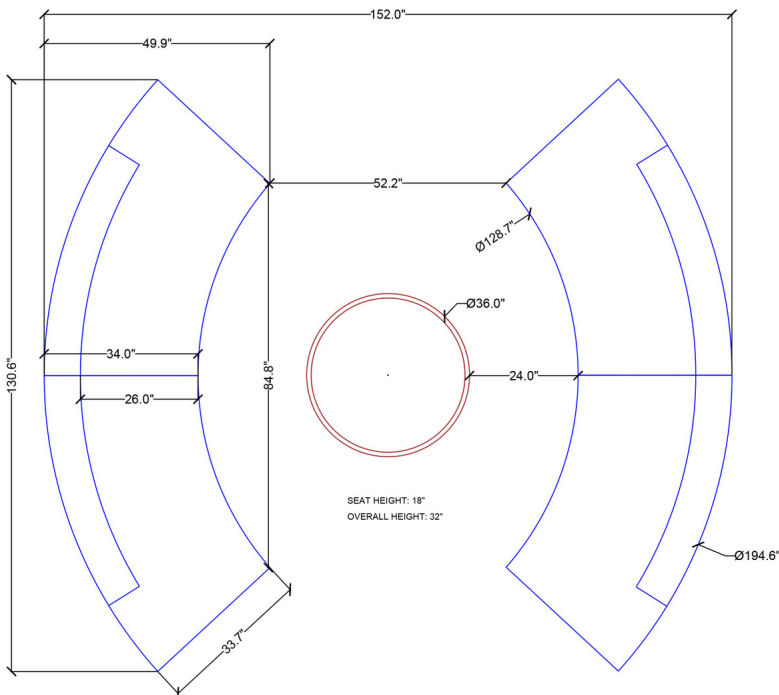

- Each Single Curved Seating Dimensions:
  - Length 130"
  - Depth 34" (curved 49.5")
  - Height 32"
  - Seating Depth 26"
  - Seating Height 18"
  - Overall Recommended Perimeter : 130" x 150"
- Center Table Dimensions:
  - Diameter 36"
  - Height 18"
- Contains:
  - (2) 8006 Open Chaises (Left)
  - (2) 8006 Open Chaise (Right)
  - (1) 8006 Center Table

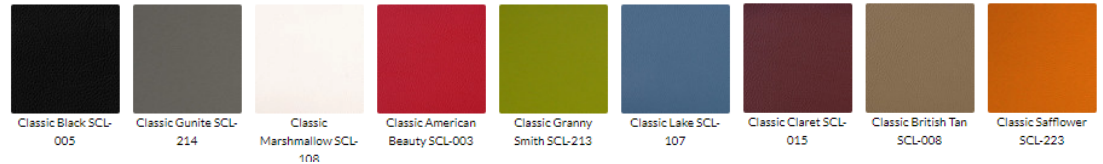

**Model: JMS-LEON-X**



**Dimensions:**

- Length: 48"
- Depth: 27"
- Height: 32"
- Seating Depth: 20"
- Seating Height: 18"



**Dimensions:**

- Length: 48" or 60"
- Depth: 27"
- Height: 32"
- Seating Depth: 20"
- Seating Height: 18"



**Dimensions:**

- Length: 27"
- Depth: 27"
- Height: 32"
- Seating Depth: 20"
- Seating Height: 18"

- This modular lounge seating is available in a variety of colors. We use only commercial grade vinyl and fabrics. All upholstery is CAL 117 certified and designed specifically for applications such as hospitality, contract, health care and education
- When combined with other modular components, pieces can be re-arranged to suit different applications and offer various layout options.
- This product was designed to occupy the least amount of space while providing the maximum amount of seating.



**Model: JMS-HST005**



Left / Right component:

- o Width: 47"
- o Depth: 27"
- o Height: 27"
- o Seating Height 18"
- o Seating Depth: 23"
- o Cushion Thickness: 4.75"



Extension component:

- o Width: 42"
- o Depth: 27"
- o Height: 27"
- o Seating Height 18"
- o Seating Depth: 23"
- o Cushion Thickness: 4.75"



Corner component:

- o Width: 27"
- o Depth: 27"
- o Height: 27"
- o Seating Height 18"
- o Seating Depth: 23"
- o Cushion Thickness: 4.75"

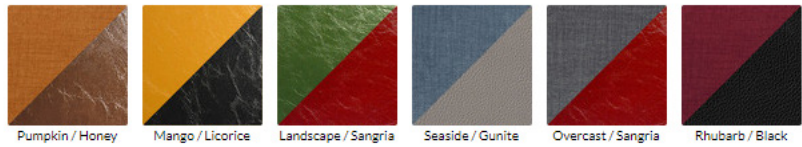

**Model: JMS-WAVE-MODULAR**

• Upholstery options:

- Symphony Collection Classic: The supple hand and texture of pebble grain leather with Resilience-SR protection. Super high-performance commercial grade-vinyl featuring 500,000 double rubs, California and Boston fire codes certifications. Common applications in hospitality, healthcare, contract, education, marine and automotive industries.
- Glossy Glaze Collection: Features beautiful, smooth and semi-glossy leather grain pattern. Excellent performance commercial grade-vinyl with 100,000 double rubs. Phthalate free and Lead free. It is California TB 117 fire code certified. Common applications id in hospitality, healthcare, contract, education, marine and automotive industries.
- Como Fabric Collection: Features beautiful and soft fabric pattern. Excellent performance commercial grade-fabric with 100,000 double rubs. Phthalate free and Lead free. It is California TB 117 fire code certified.
- Customer own material options are available

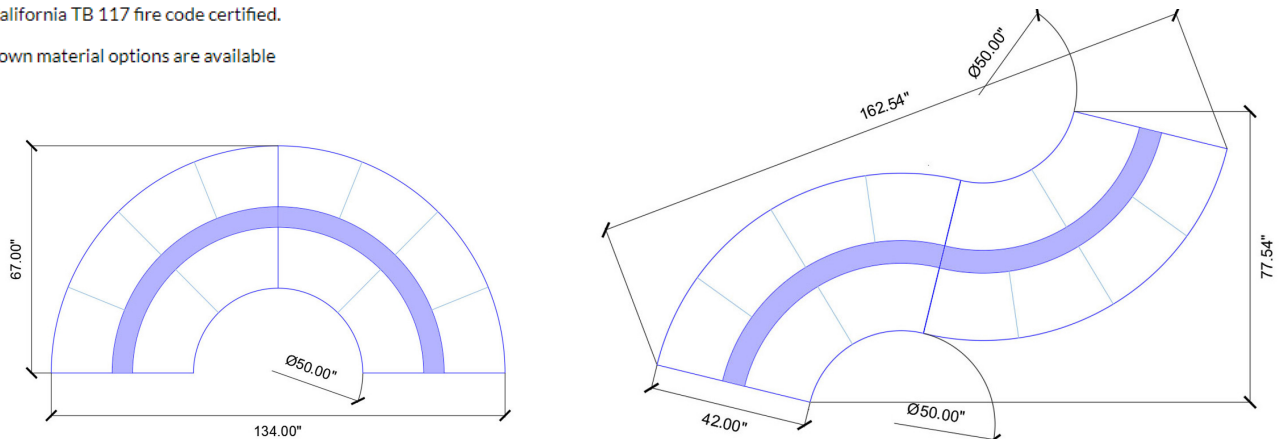





Height (floor to top):

- 36 inches
- 42 inches

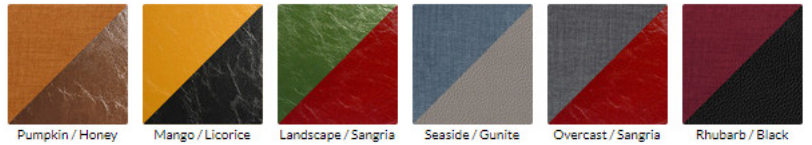

**Model: JMS-WAVE-PACKAGE**

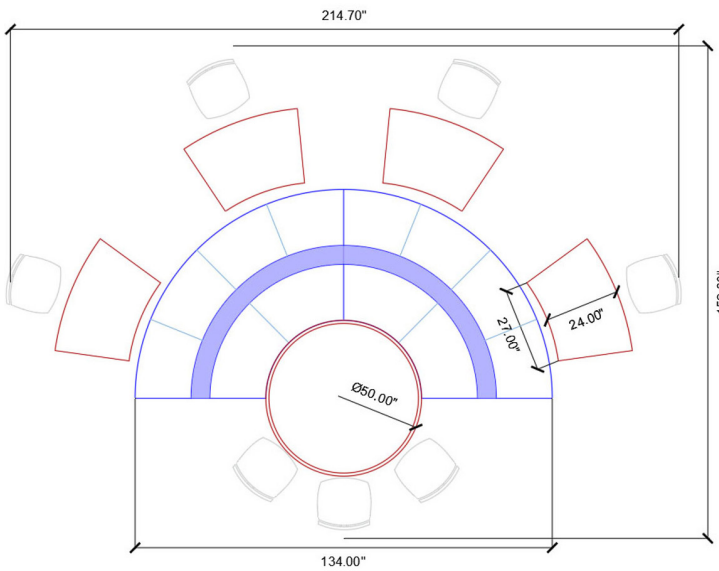

- An exclusive modern two-sided lounge booth seating.
- Space efficient design which allows you to capitalize on your available space while providing the most seating capacity.
- Built to be sturdy, pieces can be transported with ease and used in high traffic areas
- Upholstered banquette seating with deep soft cushioned padding for the most comfort and support
- Frame is made from solid wood. Cushions are made of high density CAL 117 certified foam. Joints are glued, stapled and screwed to ensure frame stability and longevity.



**Model: JMS-LAREDO**

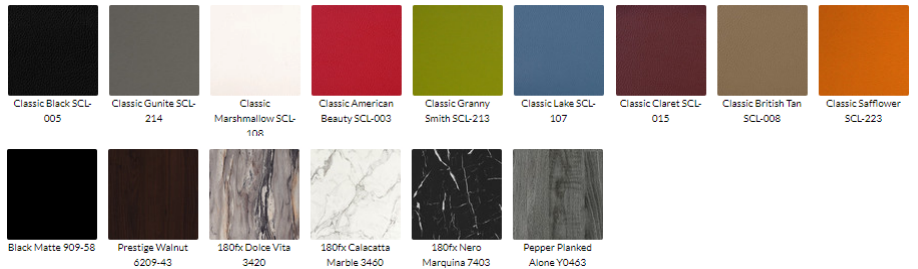

- Featuring a premium laminated finish arms, which are thoroughly protected from heat, moisture and scratches under normal use conditions.
- Each arm has a power outlet with [2] USB-A Ports and [2] 110v Outlets (as pictured)
- The base with legs are made from fully welded gunmetal frame - providing commercial environment reliability.
- Dimensions:
  - Overall Length: 120"
  - Overall Width: 27"
  - Overall Height: 37"
  - Seating Height: 17"
  - Seating Depth: 22"
  - Arm Height: 31"
  - Arm Width: 7"
- Components
  - [1] Left Side L60" x D27" x H37"
  - [1] Right Side L60 x D27" x H37"
  - Optional Side Table: L27" x W27" x H17" | Table Top Height: 6"

Short Extension



*Upholstery:*  
Classic Black SCL

Short Corner



*Upholstery:*  
Classic Black SCL-005

- Luxurious and handmade product will give your establishment or event an exclusive design with commercial grade quality.
- Upholstery is Classic Super Performance:
  - A supple leather grain with Resilience-TM protection.
  - Super high-performance commercial grade-vinyl features an abrasion resistance of 500,000 double rubs, which is approximately 5-10 times more than any upholstery on the market.
  - The Classic Super Performance vinyl is also Phthalate free and Lead free. It is California TB 117 fire code certified.
  - Common applications id in hospitality, healthcare, contract, education, marine and automotive industries.
- Frame is made from solid wood. Cushions are made of high density CAL 117 certified foam. Joints are glued, stapled and screwed to ensure frame stability and longevity.

## Model: JMS-601

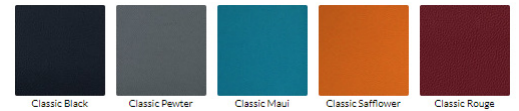

- Dimensions:
  - Extension Component: Length 24" | Depth 24" | Height 34" | Seating Depth 18" | Seating Height 18"
  - Corner Component: Length 24" | Depth 24" | Height 34" | Seating Depth 18" | Seating Height 18"
  - Overall Length: 72" x 120" x 72"
- Contains:
  - (2) 601 Short Corner Components
  - (7) 601 Extension Components



- Width: 60" (2-Seater) or 73" (3-Seater)
- Depth: 27"
- Height: 28"
- Seating Height 18"
- Seating Depth: 24"
- Each Arm: 6"



## Model: JMS-LUGANO-X

- Lugano is a modern two-seater sofa, which is well tailored for superb comfort.
- Lugano collection provides perfect contemporary seating solutions for public spaces in high traffic environment.
- **Classic Super Performance Upholstery:**
  - The fabrics are handcrafted to withstand the rigorous demands of commercial interiors within restaurants, nightclubs, education, hospitality, corporate, and healthcare environments.
  - How it feels: Soft and supple hand with a true leather-pattern and texture. Performance specifications: Abrasion resistance contract-grade 500,000 double rubs. Enhanced stain resistance with a liquid barrier.
  - Environmentally friendly: Phthalate Free, BPA Free, Formaldehyde Free and Lead Free. Fully compliant with all major flammability requirements such California TB 117, NFPA 260 and FMVSS 302.
  - *Upholstery Care & Cleaning:* Prompt cleaning is always recommended. Clean the soiled area with mild soap and water, then rinse with fresh water and wipe down with a clean cloth.
- Carbon steel frame is fully welded with a powder coated gunmetal finish.



- Width: 60" (2-Seater) or 73" (3-Seater)
- Depth: 27"
- Height: 28"
- Seating Height 17.5"
- Seating Depth: 21"
- Each Arm: 6"



- Width: 36"
- Depth: 27"
- Height: 28"
- Seating Height 17.5"
- Seating Depth: 21"
- Each Arm: 6"

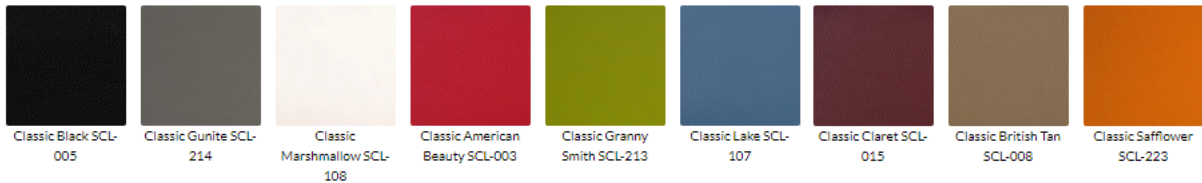

## Model: JMS-LUGANO-Z (Sofa / Chair)

### • *Classic Super Performance Upholstery:*

- The fabrics are handcrafted to withstand the rigorous demands of commercial interiors within restaurants, nightclubs, education, hospitality, corporate, and healthcare environments.
- How it feels: Soft and supple hand with a true leather-pattern and texture. Performance specifications: Abrasion resistance contract-grade 500,000 double rubs. Enhanced stain resistance with a liquid barrier.
- Environmentally friendly: Phthalate Free, BPA Free, Formaldehyde Free and Lead Free. Fully compliant with all major flammability requirements such as California TB 117, NFPA 260 and FMVSS 302.
- *Upholstery Care & Cleaning:* Prompt cleaning is always recommended. Clean the soiled area with mild soap and water, then rinse with fresh water and wipe down with a clean cloth.

- Cushions are made of high density CAL 117 certified foam. Joints are glued, stapled and screwed to ensure frame stability and longevity.





- Length: 48" (2-Seater), 73" (3-Seater)
- Depth: 27"
- Height: 32"
- Seating Depth: 20"
- Seating Height: 18"



- Length: 27"
- Depth: 27"
- Height: 32"
- Seating Depth: 20"
- Seating Height: 18"



## Model: JMS-LEON-X (Sofa / Chair)

- This product is available in a variety of colors and textures. We use only commercial grade vinyl and fabrics. All upholstery is CAL 117 certified and designed specifically for applications such as hospitality, contract, health care and education
- **Classic Super Performance Upholstery:**
  - The fabrics are handcrafted to withstand the rigorous demands of commercial interiors within restaurants, nightclubs, education, hospitality, corporate, and healthcare environments.
  - How it feels: Soft and supple hand with a true leather-pattern and texture. Performance specifications: Abrasion resistance contract-grade 500,000 double rubs. Enhanced stain resistance with a liquid barrier.
  - Environmentally friendly: Phthalate Free, BPA Free, Formaldehyde Free and Lead Free. Fully compliant with all major flammability requirements such as California TB 117, NFPA 260 and FMVSS 302.
  - **Upholstery Care & Cleaning:** Prompt cleaning is always recommended. Clean the soiled area with mild soap and water, then rinse with fresh water and wipe down with a clean cloth.
- Gunmetal powder coated carbon steel frame is fully welded - built to be used in high traffic areas.
- This product was designed to occupy the least amount of space while providing the maximum amount of seating.



- o Length: 96"
- o Depth: 27"
- o Height: 32"
- o Seating Depth: 20"
- o Seating Height: 18"
- o *Optional* Center Table:
  - Square: 27"
  - Height: 17.5"



## Model: JMS-LEON-X (Long Sofa)

- This product is available in a variety of colors and textures. We use only commercial grade vinyl and fabrics.. All upholstery is CAL 117 certified and designed specifically for applications such us hospitality, contract, health care and education
- **Classic Super Performance Upholstery:**
  - o The fabrics are handcrafted to withstand the rigorous demands of commercial interiors within restaurants, nightclubs, education, hospitality, corporate, and healthcare environments.
  - o How it feels: Soft and supple hand with a true leather-pattern and texture. Performance specifications: Abrasion resistance contract-grade 500,000 double rubs. Enhanced stain resistance with a liquid barrier.
  - o Environmentally friendly: Phthalate Free, BPA Free, Formaldehyde Free and Lead Free. Fully compliant with all major flammability requirements such California TB 117, NFPA 260 and FMVSS 302.
  - o *Upholstery Care & Cleaning:* Prompt cleaning is always recommended. Clean the soiled area with mild soap and water, then rinse with fresh water and wipe down with a clean cloth.
- Gunmetal powder coated carbon steel frame is fully welded - built to be used in high traffic areas.
- This product was designed to occupy the least amount of space while providing the maximum amount of seating.
- Optional Walnut Center Table: upholstery same as sofas, powder coated carbon steel frame is fully welded - built to be used in high traffic areas. Laminate Formica® Table Top is 1.125" - Laminate features fire resistance Grade 32 / 50. Stain, scratch and impact resistant under normal use conditions.
- Contains:
  - o [1] Left Side Sofa 48"
  - o [1] Right Side Sofa 48"
  - o [1] *Optional* Center Table 27"

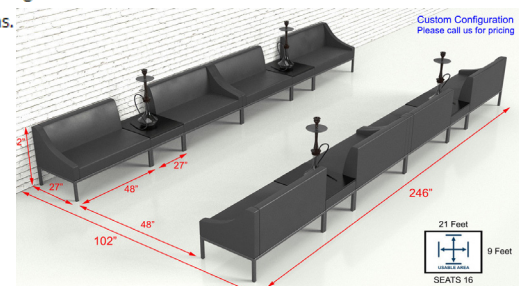



- Length: 48" (2-Seater), 73" (3-Seater)
- Depth: 27"
- Height: 31"
- Seating Depth: 21"
- Seating Height: 16.5"



- Length: 27"
- Depth: 27"
- Height: 31"
- Seating Depth: 21"
- Seating Height: 16.5"



## Model: JMS-CAPRI (Sofa / Chair)

- The clean lines design with a button-tufted back upholstery will give your establishment or event an exclusive and an impressive modern appeal. Please note you can request for the sofa to be build without back buttons.
- **Classic Super Performance Upholstery:**
  - The fabrics are handcrafted to withstand the rigorous demands of commercial interiors within restaurants, nightclubs, education, hospitality, corporate, and healthcare environments.
  - How it feels: Soft and supple hand with a true leather-pattern and texture. Performance specifications: Abrasion resistance contract-grade 500,000 double rubs. Enhanced stain resistance with a liquid barrier.
  - Environmentally friendly: Phthalate Free, BPA Free, Formaldehyde Free and Lead Free. Fully compliant with all major flammability requirements such California TB 117, NFPA 260 and FMVSS 302.
  - *Upholstery Care & Cleaning:* Prompt cleaning is always recommended. Clean the soiled area with mild soap and water, then rinse with fresh water and wipe down with a clean cloth.
- **Soft-Feel Como Fabric Upholstery:**
  - Features beautiful and soft fabric pattern.
  - Excellent performance commercial grade-fabric with 100,000 double rubs.
  - Phthalate free and Lead free. It is California TB 117 fire code certified.
  - Common applications id in hospitality, healthcare, contract, education, marine and automotive industries.







- o Length 51" (2-Seater), 70" (3-Seater)
- o Depth 28"
- o Height 31"



- Width 31"
- Depth 28"
- Height 31"



## Model: JMS-OSCAR (Sofa / Chair)

- Frame is built of solid hardwood. Cushion is made of high density CAL 117 certified foam. Joints are glued, stapled and screwed to ensure frame stability and longevity..
- The clean lines design will give your establishment or event an exclusive and an impressive modern appeal.
- **Classic Super Performance Upholstery:**
  - o The fabrics are handcrafted to withstand the rigorous demands of commercial interiors within restaurants, nightclubs, education, hospitality, corporate, and healthcare environments.
  - o How it feels: Soft and supple hand with a true leather-pattern and texture. Performance specifications: Abrasion resistance contract-grade 500,000 double rubs. Enhanced stain resistance with a liquid barrier.
  - o Environmentally friendly: Phthalate Free, BPA Free, Formaldehyde Free and Lead Free. Fully compliant with all major flammability requirements such California TB 117, NFPA 260 and FMVSS 302.
  - o *Upholstery Care & Cleaning:* Prompt cleaning is always recommended. Clean the soiled area with mild soap and water, then rinse with fresh water and wipe down with a clean cloth.
- The 22" depth seating surface allows for ample seating space and comfort.
- 107° seating angle provides a very comfortable sitting position.

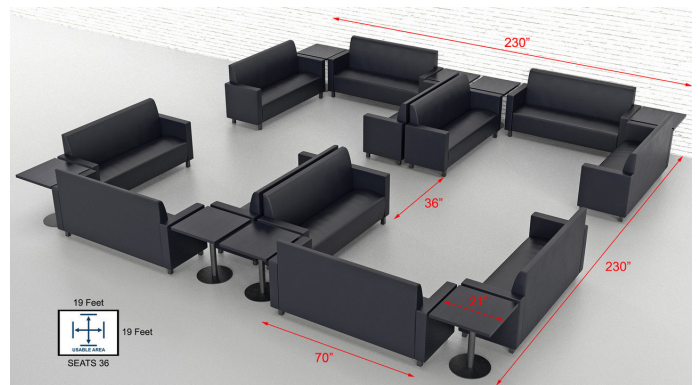



- Length: 54"
- Depth: 27"
- Height: 42"
- Seating Depth: 23"
- Seating Height: 17"
- Each Arm: 3"

Contains [1] 48" Legacy Button Tufted Extension + [2] Arms



- Length: 102"
- Depth: 27"
- Height: 42"
- Seating Depth: 22"
- Seating Height: 17"

Contains [2] 48" Legacy Button Tufted Parts + [2] Arms



## Model: JMS-LEGACY-LBT (Sofa / Chair)

### • *Classic Super Performance Upholstery:*

- The fabrics are handcrafted to withstand the rigorous demands of commercial interiors within restaurants, nightclubs, education, hospitality, corporate, and healthcare environments.
- How it feels: Soft and supple hand with a true leather-pattern and texture. Performance specifications: Abrasion resistance contract-grade 500,000 double rubs. Enhanced stain resistance with a liquid barrier.
- Environmentally friendly: Phthalate Free, BPA Free, Formaldehyde Free and Lead Free. Fully compliant with all major flammability requirements such California TB 117, NFPA 260 and FMVSS 302.
- *Upholstery Care & Cleaning:* Prompt cleaning is always recommended. Clean the soiled area with mild soap and water, then rinse with fresh water and wipe down with a clean cloth.
- Built to be both lightweight and sturdy, pieces can be transported with ease and used in high traffic areas.
- Frame is built of solid hardwood. Cushion is made of high density CAL 117 certified foam. Joints are glued, stapled and screwed to ensure frame stability and longevity.
- This product was designed to occupy the least amount of space while providing the maximum amount of seating.



- Width: (2-Seater) 58.5" or (3-Seater) 83.5"
- Depth: 28"
- Height: 28"
- Seating Height 17.5"
- Seating Depth: 21"

- Width: 37.5"
- Depth: 28"
- Height: 28"
- Seating Height 17.5"
- Seating Depth: 21"

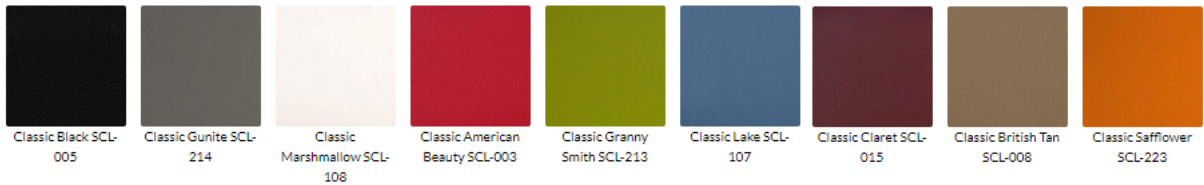

## Model: JMS-VICTOR (Sofa / Chair)

- **Classic Super Performance Upholstery:**
  - The fabrics are handcrafted to withstand the rigorous demands of commercial interiors within restaurants, nightclubs, education, hospitality, corporate, and healthcare environments.
  - How it feels: Soft and supple hand with a true leather-pattern and texture. Performance specifications: Abrasion resistance contract-grade 500,000 double rubs. Enhanced stain resistance with a liquid barrier.
  - Environmentally friendly: Phthalate Free, BPA Free, Formaldehyde Free and Lead Free. Fully compliant with all major flammability requirements such California TB 117, NFPA 260 and FMVSS 302.
  - *Upholstery Care & Cleaning:* Prompt cleaning is always recommended. Clean the soiled area with mild soap and water, then rinse with fresh water and wipe down with a clean cloth.
- Cushions are made of high density CAL 117 certified foam. Joints are glued, stapled and screwed to ensure frame stability and longevity.





- o Length: 52" or 73"
- o Depth: 27"
- o Height: 30"
- o Seating Height 18.5"
- o Seating Depth: 23"
- o Cushion Thickness: 3"



- o Length: 36"
- o Depth: 27"
- o Height: 30"
- o Seating Height 18.5"
- o Seating Depth: 23"
- o Cushion Thickness: 3"

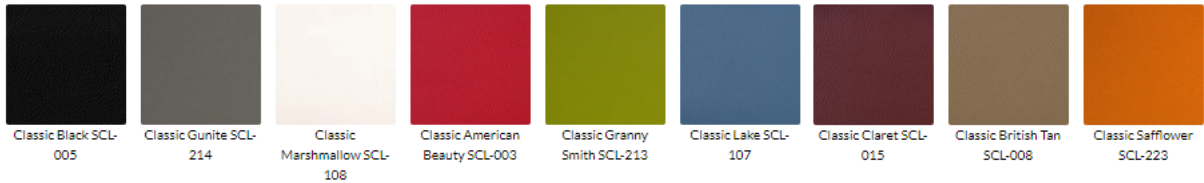

## Model: JMS-HST002 (Sofa / Chair)

- HST002 sofa is a part of a modern urban collection, which is well tailored for superb comfort. HST002 collection provides perfect contemporary seating solutions for public spaces in your high traffic environment.
- Carbon steel frame is fully welded with a gunmetal powder coated finish.
- The featured sofa will give your establishment or event an exclusive design with commercial-grade quality.
- **Classic Super Performance Upholstery:**
  - o The fabrics are handcrafted to withstand the rigorous demands of commercial interiors within restaurants, nightclubs, education, hospitality, corporate, and healthcare environments.
  - o How it feels: Soft and supple hand with a true leather-pattern and texture. Performance specifications: Abrasion resistance contract-grade 500,000 double rubs. Enhanced stain resistance with a liquid barrier.
  - o Environmentally friendly: Phthalate Free, BPA Free, Formaldehyde Free and Lead Free. Fully compliant with all major flammability requirements such California TB 117, NFPA 260 and FMVSS 302.





- Length: 52" or 73"
- Depth: 27"
- Height: 27"
- Seating Height 18"
- Seating Depth: 23"



- Length: 36"
- Depth: 27"
- Height: 27"
- Seating Height 18"
- Seating Depth: 23"

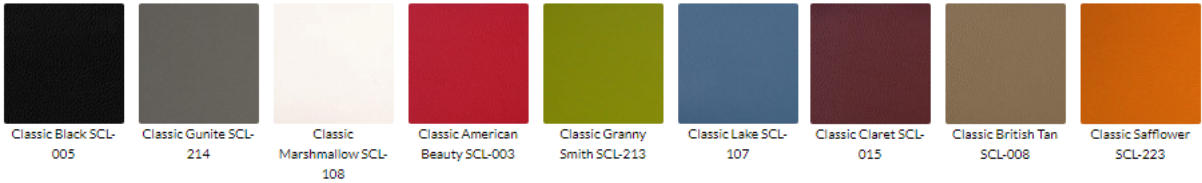

## Model: JMS-HST005 (Sofa / Chair)

Uniquely crafted, with Modern mid century style and exceptional comfort as its forte, Our HST005 Collection effortlessly finds its place in corporate lobbies, healthcare environments, hospitality lounges and more. Modular seating configurations for any open space areas will provide maximum seating potential while showing its style as a stand-alone Sofa or Chairs, that serves any number of purposes.

- HST005 chair is part of a modern urban collection, which is well tailored for superb comfort. HST005 collection provides perfect contemporary seating solutions for public spaces in your high traffic environment.
- Carbon steel frame is fully welded with a gunmetal powder coated finish.





- Length: 48" (2-Seater), 73" (3-Seater)
- Depth: 27"
- Height: 32"
- Seating Depth: 20"
- Seating Height: 18"
- Each Arm: 3"



- Length: 27"
- Depth: 27"
- Height: 32"
- Seating Depth: 20"
- Seating Height: 18"
- Each Arm: 3"



Classic Black SCL-005

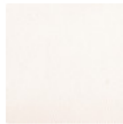

Classic Marshmallow SCL-108

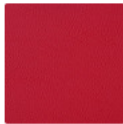

Classic American Beauty SCL-003



Classic Granny Smith SCL-213

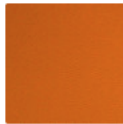

Classic Safflower SCL-223



Glaze Honey SGL-006

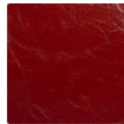

Glaze Sangria SGL-109



Glaze Mango SGL-009

## Model: JMS-LEON-X (Sofa / Chair)

- This product is available in a variety of colors and textures. We use only commercial grade vinyl and fabrics. All upholstery is CAL 117 certified and designed specifically for applications such as hospitality, contract, health care and education
- Gunmetal powder coated carbon steel frame is fully welded - built to be used in high traffic areas.
- This product was designed to occupy the least amount of space while providing the maximum amount of seating.



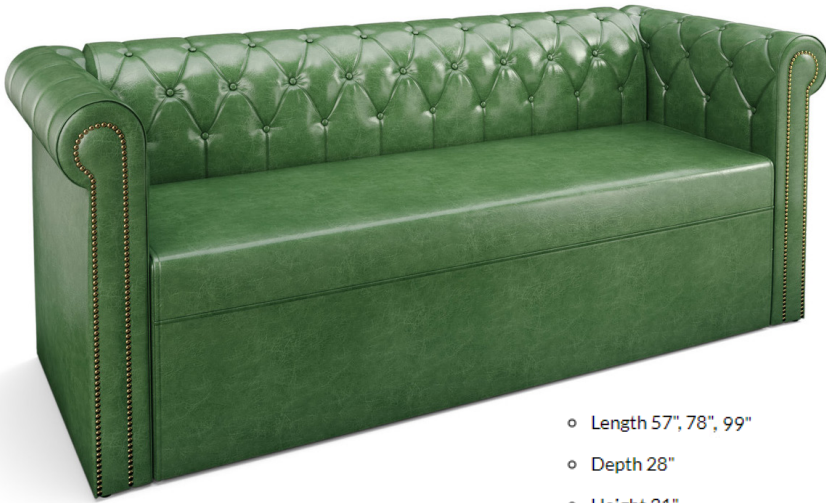

- Length 57", 78", 99"
- Depth 28"
- Height 31"
- Seating Depth 21"
- Seating Height 17"



- Length 41"
- Width 29"
- Height 31"
- Seating Depth 20.5"
- Seating Height 17.5"



Classic Gunite SCL-214

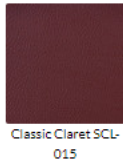

Classic Claret SCL-015



Classic British Tan SCL-008

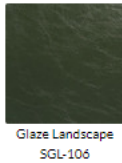

Glaze Landscape SGL-106

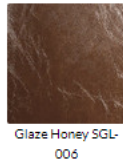

Glaze Honey SGL-006



Glaze Sangria SGL-109

## Model: JMS-ESCAPE (Sofa / Chair)

- The Escape collection responds to the realities of lounging and the rigors of everyday use in high traffic area, a perfect addition to any hospitality space.
- Versatile, beautiful, luxurious and modular - fits nicely in most spaces.
- Upholstery options:
  - Symphony Collection Classic: The supple hand and texture of pebble grain leather with Resilience-SR protection. Super high-performance commercial grade-vinyl featuring 500,000 double rubs, California and Boston fire codes certifications. Common applications in hospitality, healthcare, contract, education, marine and automotive industries.
  - Glossy Glaze Collection: Features beautiful, smooth and semi-glossy leather grain pattern. Excellent performance commercial grade-vinyl with 100,000 double rubs. Phthalate free and Lead free. It is California TB 117 fire code certified. Common applications id in hospitality, healthcare, contract, education, marine and automotive industries.





- o Overall Length: 48" or 73"
- o Overall Depth: 27"
- o Overall Height: 31"
- o Seating Depth: 19"
- o Seating Height: 16.5"



- o Overall Length: 27"
- o Overall Depth: 27"
- o Overall Height: 31"

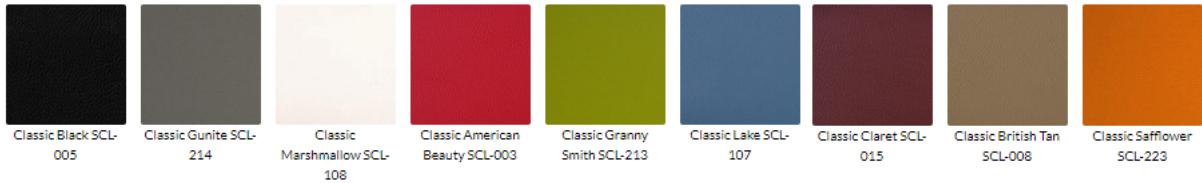

## Model: JMS-PORTER (Sofa / Chair)

### • *Classic Super Performance Upholstery:*

- o The fabrics are handcrafted to withstand the rigorous demands of commercial interiors within restaurants, nightclubs, education, hospitality, corporate, and healthcare environments.
  - o How it feels: Soft and supple hand with a true leather-pattern and texture. Performance specifications: Abrasion resistance contract-grade 500,000 double rubs. Enhanced stain resistance with a liquid barrier.
  - o Environmentally friendly: Phthalate Free, BPA Free, Formaldehyde Free and Lead Free. Fully compliant with all major flammability requirements such California TB 117, NFPA 260 and FMVSS 302.
  - o *Upholstery Care & Cleaning:* Prompt cleaning is always recommended. Clean the soiled area with mild soap and water, then rinse with fresh water and wipe down with a clean cloth.
- Featured handmade sofa will give your establishment or event an exclusive design with commercial grade quality.
  - Built to be both lightweight and sturdy - designed to be used in high traffic areas.
  - Cushion is made of high density CAL 117 certified foam. Joints are glued, stapled and screwed to ensure frame stability and longevity.





- Length: 48" (2-Seater), 73" (3-Seater)
- Depth: 27"
- Height: 34"
- Seating Depth: 21"
- Seating Height: 18"
- Each Arm: 3"



- Length: 27"
- Depth: 27"
- Height: 34"
- Seating Depth: 21"
- Seating Height: 18"
- Each Arm: 3"

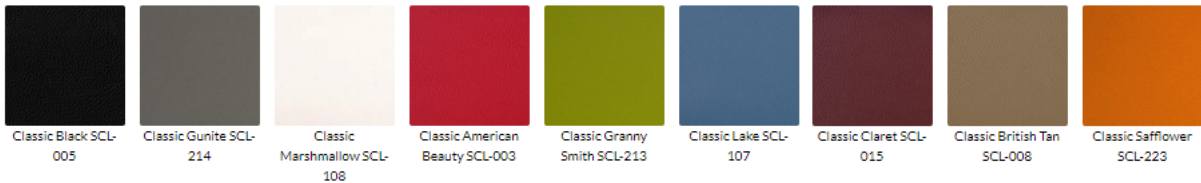

## Model: JMS-SCANIA (Sofa / Chair with optional Swing Tray)

- **Classic Super Performance Upholstery:**
  - The fabrics are handcrafted to withstand the rigorous demands of commercial interiors within restaurants, nightclubs, education, hospitality, corporate, and healthcare environments.
  - How it feels: Soft and supple hand with a true leather-pattern and texture. Performance specifications: Abrasion resistance contract-grade 500,000 double rubs. Enhanced stain resistance with a liquid barrier.
  - Environmentally friendly: Phthalate Free, BPA Free, Formaldehyde Free and Lead Free. Fully compliant with all major flammability requirements such California TB 117, NFPA 260 and FMVSS 302.
- Chair's frame is made from solid wood. Base frame is made from 1" carbon steel powder coated gunmetal finish.
- Cushions are made of high density CAL 117 certified foam. Joints are glued, stapled and screwed to ensure frame stability and longevity.
- There is one power outlet installed on right side of the chair with 2x USBs and 2x 110V ports.





- o Length: 48" (2-Seater), 73" (3-Seater)
- o Depth: 27"
- o Height: 32"
- o Seating Depth: 20"
- o Seating Height: 17"
- o Each Arm: 3"



- o Length: 27"
- o Depth: 27"
- o Height: 32"
- o Seating Depth: 20"
- o Seating Height: 17"
- o Each Arm: 3"



## Model: JMS-LEON-Z (Sofa / Chair)

- **Classic Super Performance Upholstery:**

- o The fabrics are handcrafted to withstand the rigorous demands of commercial interiors within restaurants, nightclubs, education, hospitality, corporate, and healthcare environments.
- o How it feels: Soft and supple hand with a true leather-pattern and texture. Performance specifications: Abrasion resistance contract-grade 500,000 double rubs. Enhanced stain resistance with a liquid barrier.
- o Environmentally friendly: Phthalate Free, BPA Free, Formaldehyde Free and Lead Free. Fully compliant with all major flammability requirements such California TB 117, NFPA 260 and FMVSS 302.
- o *Upholstery Care & Cleaning:* Prompt cleaning is always recommended. Clean the soiled area with mild soap and water, then rinse with fresh water and wipe down with a clean cloth.

- This product was designed to occupy the least amount of space while providing the maximum amount of seating.



- o Length: 96" (Left Side 48" and Right Side 48")



- Length: 48" (2-Seater), 73" (3-Seater)
- Depth: 27"
- Height: 42"
- Seating Depth: 23"
- Seating Height: 17"
- Each Arm: 3"



- Length: 27"
- Depth: 27"
- Height: 42"
- Seating Depth: 23"
- Seating Height: 17"
- Each Arm: 3"



## Model: JMS-NORA-4LG (Sofa / Chair)

### • Classic Super Performance Upholstery:

- The fabrics are handcrafted to withstand the rigorous demands of commercial interiors within restaurants, nightclubs, education, hospitality, corporate, and healthcare environments.
- How it feels: Soft and supple hand with a true leather-pattern and texture. Performance specifications: Abrasion resistance contract-grade 500,000 double rubs. Enhanced stain resistance with a liquid barrier.
- Environmentally friendly: Phthalate Free, BPA Free, Formaldehyde Free and Lead Free. Fully compliant with all major flammability requirements such as California TB 117, NFPA 260 and FMVSS 302.
- Upholstery Care & Cleaning: Prompt cleaning is always recommended. Clean the soiled area with mild soap and water, then rinse with fresh water and wipe down with a clean cloth.





- Length: 73" (3-Seater)
- Depth: 27"
- Height: 42"
- Seating Depth: 23"
- Seating Height: 17"
- Each Arm: 3"

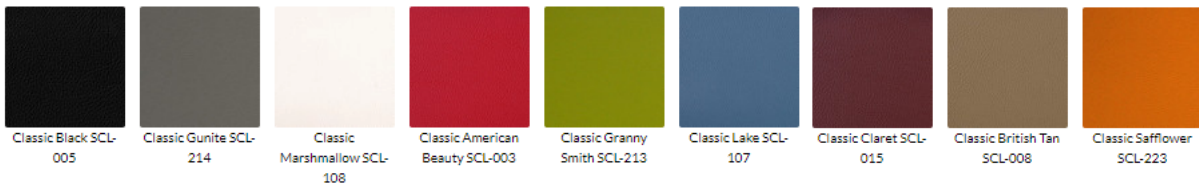

## Model: JMS-NICOLE (Sofa / Chair)

- **Classic Super Performance Upholstery:**
  - The fabrics are handcrafted to withstand the rigorous demands of commercial interiors within restaurants, nightclubs, education, hospitality, corporate, and healthcare environments.
  - How it feels: Soft and supple hand with a true leather-pattern and texture. Performance specifications: Abrasion resistance contract-grade 500,000 double rubs. Enhanced stain resistance with a liquid barrier.
  - Environmentally friendly: Phthalate Free, BPA Free, Formaldehyde Free and Lead Free. Fully compliant with all major flammability requirements such as California TB 117, NFPA 260 and FMVSS 302.
  - *Upholstery Care & Cleaning:* Prompt cleaning is always recommended. Clean the soiled area with mild soap and water, then rinse with fresh water and wipe down with a clean cloth.
- One power outlet is installed at the center of the base, provides 2x 110v and 2x USB ports.





- Length 76"
- Depth 29"
- Height 47"
- Seat Height 16"
- Seat Depth 21"



- Length 42"
- Depth 29.5"
- Height 47"
- Seating Depth 21"
- Seating Height 16"



## Model: JMS-MONACO (Sofa / Chair)

- The classic lines and style of this furniture are there to give any space in your business with the elegance and coziness you crave. With a tall back for support and comfort, as well as sturdy wooden legs for durability, this model allows you to integrate both style and satisfaction. This intuitive model offers even more! A perfect setting for your business along with being the perfect fit for any club or bar, it's tall back provides desired privacy for a VIP or lounge area.
- Features diamond tufting detail on the seating back for a sophisticated, sleek look
- Upholstery options:
  - Classic Super Performance:
    - The fabrics are handcrafted to withstand the rigorous demands of commercial interiors within restaurants, nightclubs, education, hospitality, corporate, and healthcare environments.
    - How it feels: soft and supple hand with a true leather-pattern and texture. Performance specifications: Abrasion resistance contract-grade 500,000 double rubs. Enhanced stain resistance with a liquid barrier.
    - Environmentally friendly: Phthalate Free, BPA Free, Formaldehyde Free and Lead Free. Fully compliant with all major flammability requirements such California TB 117, NFPA 260 and FMVSS 302.
    - Care & Cleaning: Prompt cleaning is always recommended. Clean the soiled area with mild soap and water, then rinse with fresh water and wipe down with a clean cloth.
  - Glossy Glaze Collection:
    - Features beautiful, smooth and semi-glossy leather grain pattern. Excellent performance commercial grade-vinyl with 100,000 double rubs.
    - Phthalate free and Lead free. It is California TB 117 fire code certified.
- Only solid hardwood products are used in the frame construction. All corners are "blocked", nailed, and glued for strength and durability.
- All of the seats and backs are high density (1.7) foam to give comfort and support
- Legs are made of solid wood in walnut finish - good for years of carefree use.



- Length 72"
- Depth 32"
- Height 43.5"
- Seating Depth 23"
- Seating Height 18"



- Length 37"
- Depth 32"
- Height 43.5"
- Seating Depth 23"
- Seating Height 18"
- Seat 23" x 30"



**Model: JMS-PATRICIA (Sofa / Chair)**

- The featured lavish lounge chair has an extra wide seating area to provide more comfort for your patrons. The modern arching arms creates a welcoming contemporary appeal.
- **Classic Super Performance Upholstery:**
  - The fabrics are handcrafted to withstand the rigorous demands of commercial interiors within restaurants, nightclubs, education, hospitality, corporate, and healthcare environments.
  - How it feels: Soft and supple hand with a true leather-pattern and texture. Performance specifications: Abrasion resistance contract-grade 500,000 double rubs. Enhanced stain resistance with a liquid barrier.
  - Environmentally friendly: Phthalate Free, BPA Free, Formaldehyde Free and Lead Free. Fully compliant with all major flammability requirements such California TB 117, NFPA 260 and FMVSS 302.
- All of the seats and backs are high density (1.7) foam to give comfort and support
- Only heavy gauge steel is used for comfortable seat and back support.





- Length: 50" (2-Seater), 75" (3-Seater)
- Depth: 27.5"
- Height: 36"
- Seating Depth: 19"
- Seating Height: 18"
- Each Arm: 3"



- Length: 27.5"
- Depth: 27.5"
- Height: 36"
- Seating Depth: 19"
- Seating Height: 18"
- Each Arm: 3"



## Model: JMS-ALPINE (Sofa / Chair)

### • *Classic Super Performance Upholstery:*

- The fabrics are handcrafted to withstand the rigorous demands of commercial interiors within restaurants, nightclubs, education, hospitality, corporate, and healthcare environments.
- How it feels: Soft and supple hand with a true leather-pattern and texture. Performance specifications: Abrasion resistance contract-grade 500,000 double rubs. Enhanced stain resistance with a liquid barrier.
- Environmentally friendly: Phthalate Free, BPA Free, Formaldehyde Free and Lead Free. Fully compliant with all major flammability requirements such as California TB 117, NFPA 260 and FMVSS 302.
- *Upholstery Care & Cleaning:* Prompt cleaning is always recommended. Clean the soiled area with mild soap and water, then rinse with fresh water and wipe down with a clean cloth.
- Built to be both lightweight and sturdy, pieces can be transported with ease and used in high traffic areas.
- Frame is built of solid hardwood. Cushion is made of high density CAL 117 certified foam. Joints are glued, stapled and screwed to ensure frame stability and longevity.
- Base sits on metal base glides
- When combined with other modular components, pieces can be re-arranged to suit different applications and offer various layout options.
- Sofa sits on four metal glides - built to be used in high traffic areas.
- This product was designed to occupy the least amount of space while providing the maximum amount of seating.

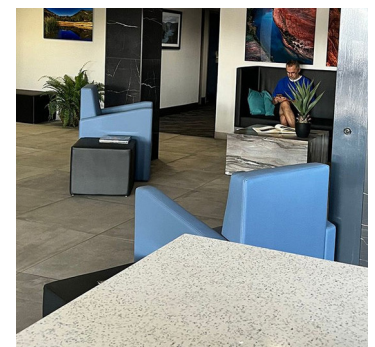



- Length: 48"
- Depth: 25.5"
- Height: 36"
- Seating Depth: 19.5"
- Seating Height: 18.5"



## Model: JMS-STELLA

- How it works: this bright and inviting armless loveseat was created to allow for easy mobility, so it can be either moved to a desired position quickly or out of the way. The front of the loveseat has two casters, so when the sofa is lifted towards the front, by using the rear handles, the loveseat now is able to be easily moved.
- Upholstery Classic Super Performance:
  - The fabrics are handcrafted to withstand the rigorous demands of commercial interiors within restaurants, nightclubs, education, hospitality, corporate, and healthcare environments.
  - How it feels: soft and supple hand with a true leather-pattern and texture.
  - Performance specifications: Abrasion resistance contract-grade 500,000 double rubs.
  - Enhanced stain resistance with a liquid barrier. Environmentally friendly: Phthalate Free, BPA Free, Formaldehyde Free and Lead Free. Fully compliant with all major flammability requirements such California TB 117, NFPA 260 and FMVSS 302.
  - Care & Cleaning: Prompt cleaning is always recommended. Clean the soiled area with mild soap and water, then rinse with fresh water and wipe down with a clean cloth.
  - Common applications in hospitality, healthcare, contract, education, marine and automotive industries.
- Stella loveseat is built to be used in high traffic areas.
- Optional: one power outlet can be installed at the center of the base, provides 2x 110v and 2x USB ports.





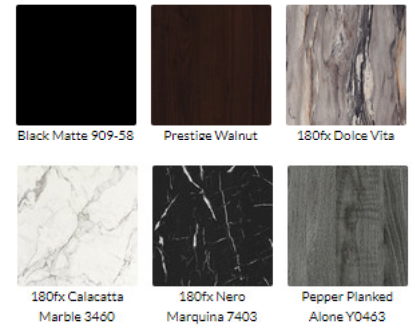

## Model: JMS-LAREDO (Optional Side Table)

- Modern commercial sofa with power charging ports and outlets - featuring convenient wide solid wood laminated arms for perfect laptop and other tech placement.
- Featuring a premium laminated finish arms, which are thoroughly protected from heat, moisture and scratches under normal use conditions.
- Each arm has a power outlet with [2] USB-A Ports and [2] 110v Outlets (as pictured)
- The base with legs are made from fully welded gunmetal frame - providing commercial environment reliability.
- Dimensions:
  - Overall Length: 120"
  - Overall Width: 27"
  - Overall Height: 37"
  - Seating Height: 17"
  - Seating Depth: 22"
  - Arm Height: 31"
  - Arm Width: 7"
- Components
  - [1] Left Side L60" x D27" x H37"
  - [1] Right Side L60 x D27" x H37"
  - Optional Side Table: L27" x W27" x H17" | Table Top Height: 6"



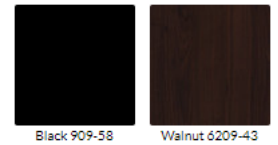

## Model: JMS-ALTA

- Upholstery is Classic Super Performance:
  - A supple leather grain with Resilience-TM protection.
  - Super high-performance commercial grade-vinyl features an abrasion resistance of 500,000 double rubs, which is approximately 5-10 times more than any chair on the market.
  - The Classic Super Performance vinyl is also Phthalate free and Lead free. It is California TB 117 fire code certified.
  - Common applications id in hospitality, healthcare, contract, education, marine and automotive industries.
- The 20" depth seating surface allows for ample seating space and comfort. This product was designed to occupy the least amount of space while providing the maximum amount of seating.
- Frame box is made from Formica® features fire resistance Grade 32 / 50. Stain, scratch and impact resistant under normal use conditions. Postform grade of 12 / 20.
- Cushions are made of high density CAL 117 certified foam. Joints are glued, stapled and screwed to ensure frame stability and longevity.
- Power outlet has 2x USBs and 2x 110V ports. We can customize the ports/outlets to meet any specs and demands.
- Gunmetal powder coated 1" carbon steel frame is fully welded - built to be used in high traffic areas.
- Dimensions:
  - Length 48" or 73"
  - Depth 27"
  - Height 37"
  - Seating Depth 20"
  - Seating Height 18"



**Upholstery:**  
Caravelle Black  
**Finish:**



## Model: JMS-IBIS

- Upholstery:
  - High-performance commercial grade-vinyl.
  - Phthalate free and Lead free.
  - It is California TB 117 fire code certified. Common applications id in hospitality, healthcare, contract, education, marine and automotive industries.
- Frame is made from solid wood. Cushions are made of high density CAL 117 certified foam. Joints are glued, stapled and screwed to ensure frame stability and longevity.
- The premium Formica wrap around the 2" back and base creates a beautiful and luxurious look. Laminate features fire resistance Grade 32 / 50. Stain, scratch and impact resistant under normal use conditions.
- Optional one power outlet features 2x 110v and 2x USB ports - installed at the center of the base.
- Dimensions:
  - Overall Length: 71"
  - Width 21"
  - Height 48"
  - Seating Depth 19"
  - Seating Height 18"



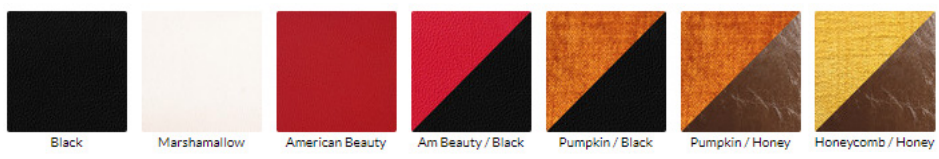
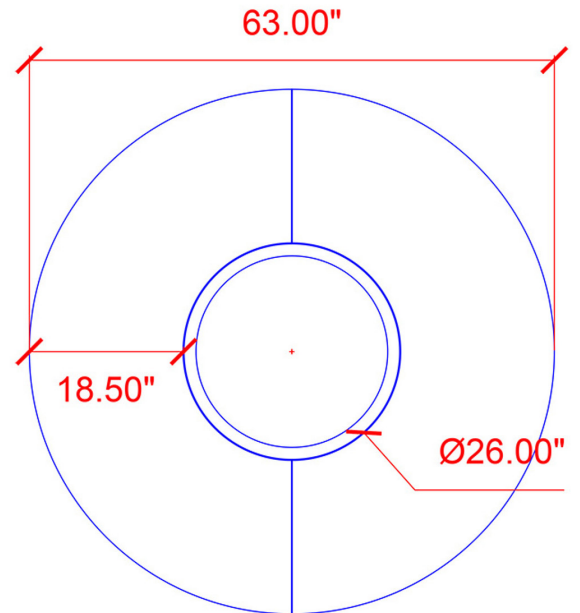

**Model: JMS-906-TOWER**

- One of our most popular event-suited seating tower that brings a modern appeal with a center-piece presentation that will surely catch the eye.
- The button-tufting upholstery adds a luxurious feel and look; while the modular design provides the ease of mobility.
- Frame is built of solid hardwood. Cushion is made of high density CAL 117 certified foam and Leggett & Platt No-Sag® springs. Joints are glued, stapled and screwed to ensure frame stability and longevity.
- The round seating surface allows for ample seating space and comfort. This product was designed to occupy the least amount of space while providing the maximum amount of seating.

- Dimensions per bench as pictured:
  - Overall Diameter: 63"
  - Seating Depth: 18.5"
  - Seating Height: 17.5"
  - Overall Height: 45"





## Model: JMS-LUXE-CHAIR

- This beautiful club chair is custom built in USA.
- Luxurious and handmade chair will give your establishment or event an exclusive design with commercial grade quality.
- Built to be both lightweight and sturdy - designed to be used in high traffic areas.
- Frame is built of solid hardwood. Cushion is made of high density CAL 117 certified foam. Joints are glued, stapled and screwed to ensure frame stability and longevity. Stands on non-marring floor glides
- Upholstery Options:
  - **Super Performance Classic Collection:**
    - The fabrics are handcrafted to withstand the rigorous demands of commercial interiors within restaurants, nightclubs, education, hospitality, corporate, and healthcare environments.
    - How it feels: Soft and supple hand with a true leather-pattern and texture. Performance specifications: Abrasion resistance contract-grade 500,000 double rubs. Enhanced stain resistance with a liquid barrier.
    - Environmentally friendly: Phthalate Free, BPA Free, Formaldehyde Free and Lead Free. Fully compliant with all major flammability requirements such California TB 117, NFPA 260 and FMVSS 302.
  - **Glossy Glaze Collection:**
    - Features beautiful, smooth and semi-glossy leather grain pattern. Excellent performance commercial grade-vinyl with 100,000 double rubs.
    - Glaze upholstery is also Phthalate free and Lead free. It is California TB 117 fire code certified.
- Dimensions
  - Width: 28"
  - Depth: 25.5"
  - Height: 30"
  - Seating Height: 18"
  - Seating Depth: 20.5"



- Width: 29.5"
- Depth: 30"
- Height: 34"
- Seating Height: 18"
- Seating Depth: 20"

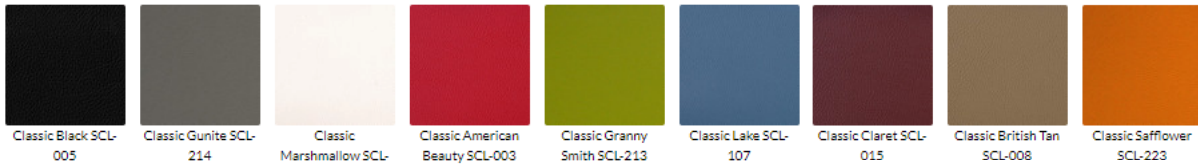

## Model: JMS-CB88-CHAIR (Optional 360° Swivel Base or Caster)

- This product is custom built in USA.
- Luxurious and handmade chair will give your establishment or event an exclusive design with commercial grade quality.
- Built to be both lightweight and sturdy - designed to be used in high traffic areas.
- Frame is built of solid hardwood. Cushion is made of high density CAL 117 certified foam. Joints are glued, stapled and screwed to ensure frame stability and longevity. Stands on non-marring floor glides
- **Optional Five Commercial-Grade Casters:**



- **Optional Swivel Base**
  - Heavy-duty swivel mechanism
  - Made of steel - extremely durable, sturdy and reliable
  - Ball bearings swivel plate provides a smooth operation





- Length 30"
- Depth: 28"
- Height: 35"
- Seating Height: 18"
- Seating Depth: 20"



Classic Black SGL-005



Glaze Licorice SGL-008

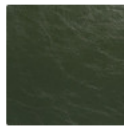

Glaze Landscape SGL-106



Glaze Honey SGL-006

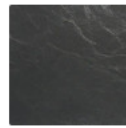

Glaze Slate SGL-110

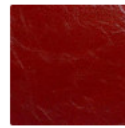

Glaze Sangria SGL-109

## Model: JMS-CB20-CHAIR (Optional 360° Swivel Base or Caster)

- This product is custom built in USA.
- Luxurious and handmade chair will give your establishment or event an exclusive design with commercial grade quality.
- Built to be both lightweight and sturdy - designed to be used in high traffic areas.
- Frame is built of solid hardwood. Cushion is made of high density CAL 117 certified foam. Joints are glued, stapled and screwed to ensure frame stability and longevity. Stands on non-marring floor glides
- **Optional Five Commercial-Grade Casters:**



- **Optional Swivel Base**
  - Heavy-duty swivel mechanism
  - Made of steel - extremely durable, sturdy and reliable
  - Ball bearings swivel plate provides a smooth operation





### Model: JMS-2034-CHAIR (Flat or Channel Tufted)

- Attractive and comfortable chair available in Flat or Channel Tufting. A great addition to any commercial space.
- This product can be custom made to match your specs or reupholstered in a variety of colors and textures within a few business days.
- Contrast of curved design features and clean lines will give your establishment or event an exclusive modern design with commercial grade quality.
- Durable construction materials include solid hardwood frames, high density foam and heavy gauge steel.
- Dimensions:
  - Length 28"
  - Depth: 25"
  - Height: 30"
  - Seating Height: 17"
  - Seating Depth: 20.5"







## Model: JMS-3105-CHAIR (Flat or Channel Tufted)

- Modern and comfortable chair available in Flat or Channel Tufting. A great addition to any commercial space.
- This product can be custom made to match your specs or reupholstered in a variety of colors and textures within a few business days.
- Contrast of curved design features and clean lines will give your establishment or event an exclusive modern design with commercial grade quality.
- Durable construction materials include solid hardwood frames, high density foam and heavy gauge steel.
- Dimensions:
  - Length 28"
  - Depth: 27"
  - Height: 34"
  - Seating Height: 18"
  - Seating Depth: 20.5"





## Model: JMS-ESCAPE-TALL-CHAIR

- The Escape collection responds to the realities of lounging and the rigors of everyday use in high traffic area, a perfect addition to any hospitality space.
- Versatile, beautiful, luxurious and modular - fits nicely in most spaces.
- Upholstery options:
  - Symphony Collection Classic: The supple hand and texture of pebble grain leather with Resilience-SR protection. Super high-performance commercial grade-vinyl featuring 500,000 double rubs, California and Boston fire codes certifications. Common applications in hospitality, healthcare, contract, education, marine and automotive industries.
  - Glossy Glaze Collection: Features beautiful, smooth and semi-glossy leather grain pattern. Excellent performance commercial grade-vinyl with 100,000 double rubs. Phthalate free and Lead free. It is California TB 117 fire code certified. Common applications in hospitality, healthcare, contract, education, marine and automotive industries.
  - Customer own material options are available
- Dimensions:
  - Length 41"
  - Width 29"
  - Height 38"
  - Seating Depth 20.5"
  - Seating Height 17.5"



- Length: 28"
- Depth: 28"
- Height: 48"
- Seating Depth: 21"
- Seating Height: 18"



## Model: JMS-TALEON-CHAIR

### • *Classic Super Performance Upholstery:*

- The fabrics are handcrafted to withstand the rigorous demands of commercial interiors within restaurants, nightclubs, education, hospitality, corporate, and healthcare environments.
- How it feels: Soft and supple hand with a true leather-pattern and texture. Performance specifications: Abrasion resistance contract-grade 500,000 double rubs. Enhanced stain resistance with a liquid barrier.
- Environmentally friendly: Phthalate Free, BPA Free, Formaldehyde Free and Lead Free. Fully compliant with all major flammability requirements such as California TB 117, NFPA 260 and FMVSS 302.
- *Upholstery Care & Cleaning:* Prompt cleaning is always recommended. Clean the soiled area with mild soap and water, then rinse with fresh water and wipe down with a clean cloth.

### • *Soft-Feel Como Fabric Upholstery:*

- Features beautiful and soft fabric pattern.
- Excellent performance commercial grade-fabric with 100,000 double rubs.
- Phthalate free and Lead free. It is California TB 117 fire code certified.
- Common applications are in hospitality, healthcare, contract, education, marine and automotive industries.
- The 21" depth seating surface allows for ample seating space and comfort. This product was designed to occupy the least amount of space while providing the maximum amount of seating.
- Built to be both lightweight and sturdy, pieces can be transported with ease and used in high traffic areas.
- Frame is built of solid hardwood. Cushion is made of high density CAL 117 certified foam. Joints are glued, stapled and screwed to ensure frame stability and longevity.
- Base sits on solid walnut wood legs

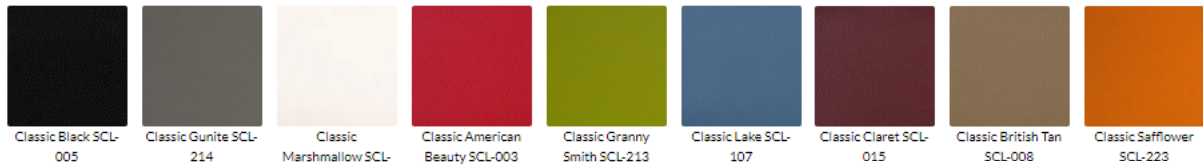

## Model: JMS-BORDO

### • *Classic Super Performance Upholstery:*

- The fabrics are handcrafted to withstand the rigorous demands of commercial interiors within restaurants, nightclubs, education, hospitality, corporate, and healthcare environments.
  - How it feels: Soft and supple hand with a true leather-pattern and texture. Performance specifications: Abrasion resistance contract-grade 500,000 double rubs. Enhanced stain resistance with a liquid barrier.
  - Environmentally friendly: Phthalate Free, BPA Free, Formaldehyde Free and Lead Free. Fully compliant with all major flammability requirements such as California TB 117, NFPA 260 and FMVSS 302.
  - *Upholstery Care & Cleaning:* Prompt cleaning is always recommended. Clean the soiled area with mild soap and water, then rinse with fresh water and wipe down with a clean cloth.
- The 19" depth seating surface allows for ample seating space and comfort. This product was designed to occupy the least amount of space while providing the maximum amount of seating.
  - Built to be both lightweight and sturdy, pieces can be transported with ease and used in high traffic areas.
  - Frame is built of solid hardwood. Cushion is made of high density CAL 117 certified foam. Joints are glued, stapled and screwed to ensure frame stability and longevity.
  - Base sits on solid walnut wood legs
  - Dimensions:
    - Length: 27"
    - Depth: 27"
    - Height: 41"
    - Seating Depth: 19"
    - Seating Height: 17"
    - Back spans from 21" to 27" width on top; with 17" height from arm



## Model: JMS-DELRAY-CHAIR (Square or Round Seat)

- **Classic Super Performance Upholstery:**

- The fabrics are handcrafted to withstand the rigorous demands of commercial interiors within restaurants, nightclubs, education, hospitality, corporate, and healthcare environments.
- How it feels: Soft and supple hand with a true leather-pattern and texture. Performance specifications: Abrasion resistance contract-grade 500,000 double rubs. Enhanced stain resistance with a liquid barrier.
- Environmentally friendly: Phthalate Free, BPA Free, Formaldehyde Free and Lead Free. Fully compliant with all major flammability requirements such California TB 117, NFPA 260 and FMVSS 302.
- *Upholstery Care & Cleaning:* Prompt cleaning is always recommended. Clean the soiled area with mild soap and water, then rinse with fresh water and wipe down with a clean cloth.
- The 21" depth seating surface allows for ample seating space and comfort. This product was designed to occupy the least amount of space while providing the maximum amount of seating.
- Built to be both lightweight and sturdy, pieces can be transported with ease and used in high traffic areas.
- Frame is built of solid hardwood. Cushion is made of high density CAL 117 certified foam. Joints are glued, stapled and screwed to ensure frame stability and longevity.
- Base sits on industrial-grade casters



- Length: 27"
- Depth: 26"
- Height: 31"
- Seating Depth: 21"
- Seating Height: 17"



- Seat Diameter: 21" Round (Small Seat), 25" Round (Large Seat)
- Overall Chair Diameter: 26" Round (Small Seat), 30" Round (Large Seat)
- Height: 30"
- Seating Height: 17"



## Model: JMS-CIGAR-TALL-CHAIR

- This perfect cigar lounge chair responds to the realities of lounging and the rigors of everyday use in high traffic area, a perfect addition to anyone seeking comfort, beauty and durability.
- Versatile, beautiful, luxurious and modular - fits nicely in most spaces.
- Upholstery options:
  - Symphony Collection Classic: The supple hand and texture of pebble grain leather with Resilience-SR protection. Super high-performance commercial grade-vinyl featuring 500,000 double rubs, California and Boston fire codes certifications. Common applications in hospitality, healthcare, contract, education, marine and automotive industries.
  - Glossy Glaze Collection: Features beautiful, smooth and semi-glossy leather grain pattern. Excellent performance commercial grade-vinyl with 100,000 double rubs. Phthalate free and Lead free. It is California TB 117 fire code certified. Common applications in hospitality, healthcare, contract, education, marine and automotive industries.
  - Customer own material options are available
- Dimensions:
  - Length 41"
  - Width 29"
  - Height 38"
  - Seating Depth 20.5"
  - Seating Height 17.5"



## Model: JMS-PADRON-CHAIR

- A modern luxurious lounge chair responds to the realities of lounging and the rigors of everyday use in high traffic area, a perfect addition to anyone seeking comfort, beauty and durability.
- Upholstery options:
  - Symphony Collection Classic: The supple hand and texture of pebble grain leather with Resilience-SR protection. Super high-performance commercial grade-vinyl featuring 500,000 double rubs, California and Boston fire codes certifications. Common applications in hospitality, healthcare, contract, education, marine and automotive industries.
  - Glossy Glaze Collection: Features beautiful, smooth and semi-glossy leather grain pattern. Excellent performance commercial grade-vinyl with 100,000 double rubs. Phthalate free and Lead free. It is California TB 117 fire code certified. Common applications id in hospitality, healthcare, contract, education, marine and automotive industries.
  - Customer own material options are available
- Elegant bronze nail trim.
- Solid walnut wood legs.
- Dimensions:
  - Length 39"
  - Width 29"
  - Height 28.5"
  - Seating Depth 21.5"
  - Seating Height 16"



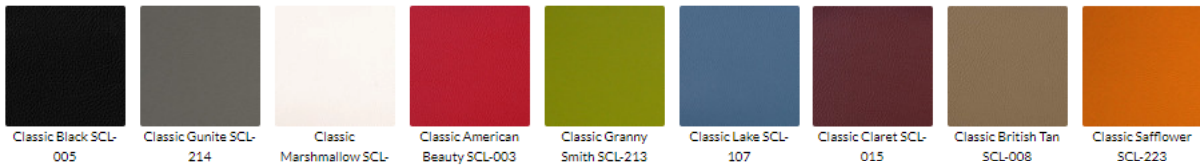

## Model: JMS-VENICE-CHAIR

- Unique and contemporary club chair with deep seat for extra comfort. Manufactured for high traffic areas.
- Upholstery options:
  - Symphony Collection Classic: The supple hand and texture of pebble grain leather with Resilience-SR protection. Super high-performance commercial grade-vinyl featuring 500,000 double rubs, California and Boston fire codes certifications. Common applications in hospitality, healthcare, contract, education, marine and automotive industries.
  - Customer own material options are available
- Fully welded gunmetal frame.
- Dimensions:
  - Length 32"
  - Width 28"
  - Height 32"
  - Seating Depth 21.5"
  - Seating Height 17"



Privacy Side Panel - Available in 41" or 51" Height



**Model: JMS-Montana**

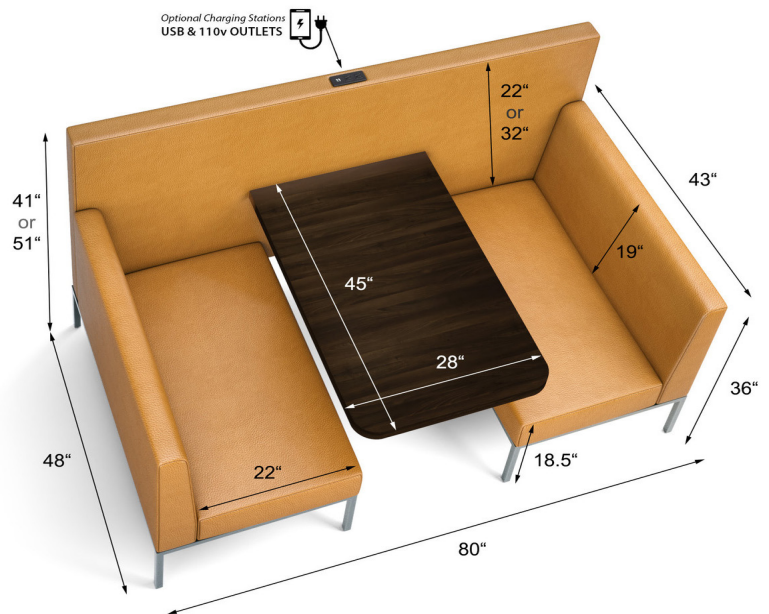
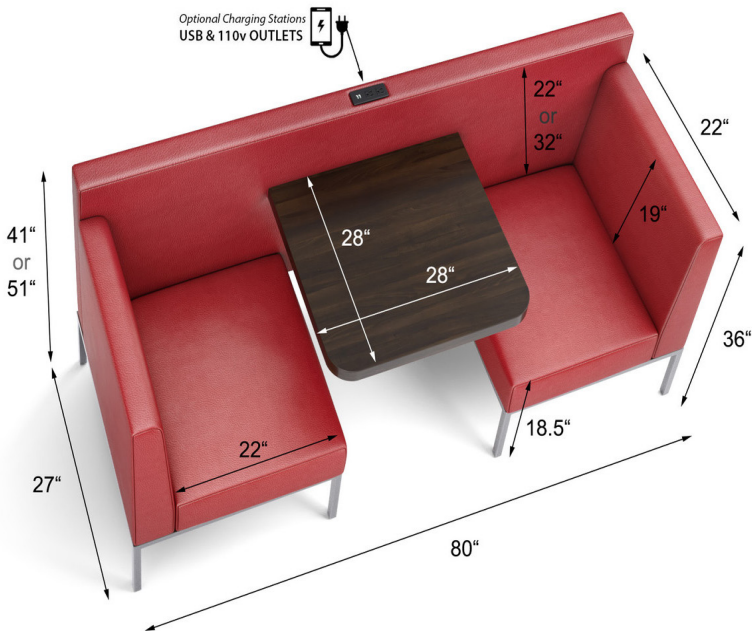



Half a Circle Booth Restaurant Seating - Contract Grade - Premium Performance Upholstery - 100% Handcrafted In USA



Half a Circle Booth Restaurant Seating - Contract Grade - Premium Channel Tufted Performance Upholstery - 100% Handcrafted In USA



Half a Circle Booth Restaurant Seating - Contract Grade - Premium Diamond Tufted Performance Upholstery - 100% Handcrafted In USA

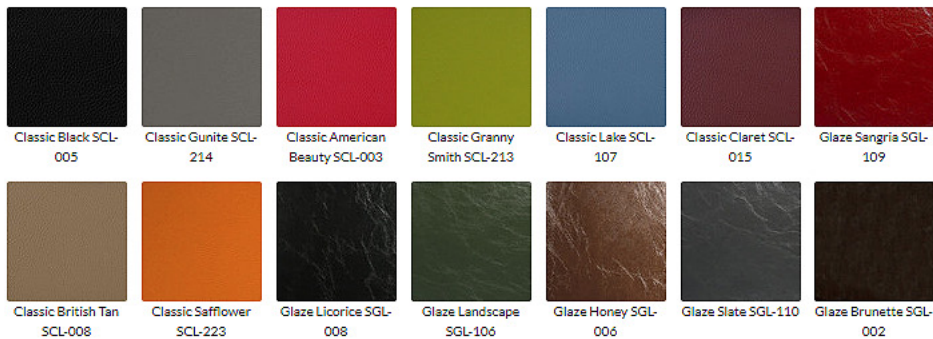

## Model: JMS-Half-Circle Booth

- The Half a Circle booth seating is fully customized to customer's specifications.
- Upholstery options:
- Classic Super Performance:
  - The fabrics are handcrafted to withstand the rigorous demands of commercial interiors within restaurants, nightclubs, education, hospitality, corporate, and healthcare environments.
  - How it feels: soft and supple hand with a true leather-pattern and texture. Performance specifications: Abrasion resistance contract-grade 500,000 double rubs. Enhanced stain resistance with a liquid barrier.
  - Environmentally friendly: Phthalate Free, BPA Free, Formaldehyde Free and Lead Free. Fully compliant with all major flammability requirements such California TB 117, NFPA 260 and FMVSS 302.
- Glossy Glaze Collection:
  - Features beautiful, smooth and semi-glossy leather grain pattern. Excellent performance commercial grade-vinyl with 100,000 double rubs.
  - Phthalate free and Lead free. It is California TB 117 fire code certified.
  - Common applications id in hospitality, healthcare, contract, education, marine and automotive industries.
- All modular components are fully assembled.
- Dimensions per bench as pictured:
  - Seating Depth: 19"
  - Seating Height: 19"
  - Overall Height: 36"
- Overall dimensions as shown for two size options:
  - 42" by 84" by 42" (table top up to 36" Round)
  - 48" by 96" by 48" (table top up to 48" Round)



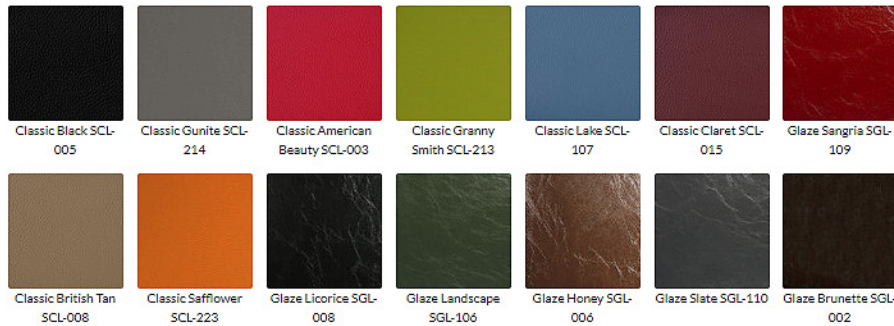
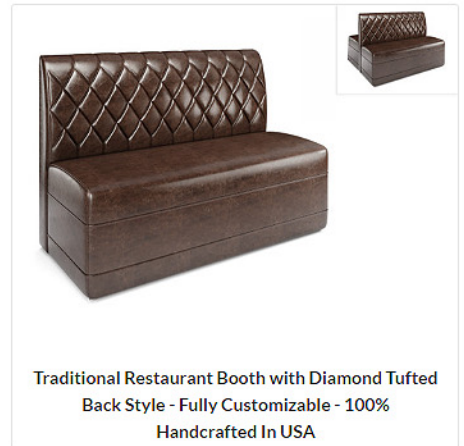
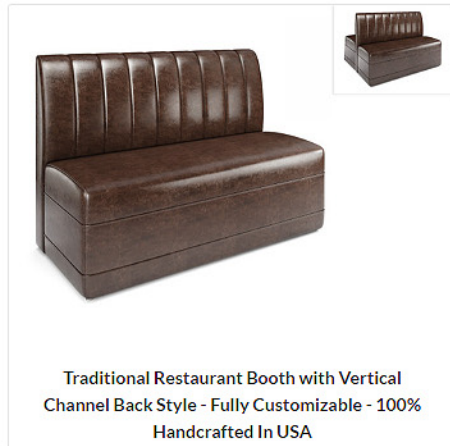

**Model: Traditional Booth (Flat / Channel / Diamond Tufted)**

- This elegant restaurant booth provides ultimate comfort, traditional style and durability.
- The 19" depth seating surface allows for ample seating space and comfort. This product was designed to occupy the least amount of space while providing the maximum amount of seating.
- Durable construction materials include solid hardwood frames build from 2"x3" heavy duty studs, high density foam 1830-1850, durable decron and heavy gauge steel.
- Frame is built of solid hardwood. Cushion is made of high density CAL 117 certified foam and Leggett & Platt No-Sag® springs. Joints are glued, stapled and screwed to ensure frame stability and longevity.
- Fully assembled and ready to use.
- Length (side to side) 48" or 60"
- Width 25" (Single), 48" (Double)
- Height (floor to top) 36" or 48"
- Seating Depth 19.5"
- Seating Height 18"w



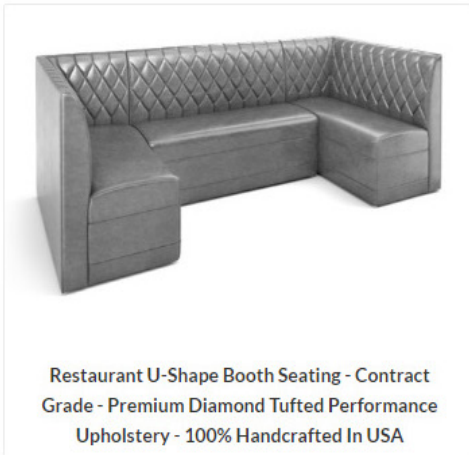
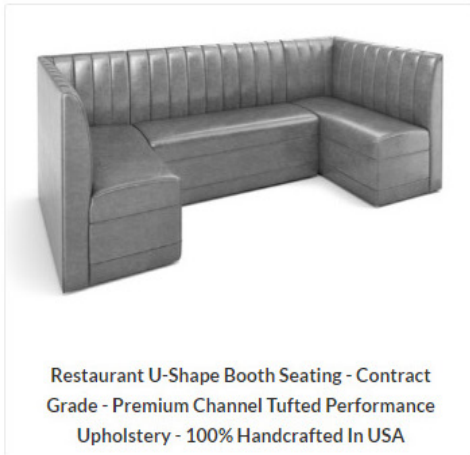

### Model: JMS-Booth U-Shape

- The Half a Circle booth seating is fully customized to customer's specifications.
- Upholstery options:
- Classic Super Performance:
  - The fabrics are handcrafted to withstand the rigorous demands of commercial interiors within restaurants, nightclubs, education, hospitality, corporate, and healthcare environments.
  - How it feels: soft and supple hand with a true leather-pattern and texture. Performance specifications: Abrasion resistance contract-grade 500,000 double rubs. Enhanced stain resistance with a liquid barrier.
  - Environmentally friendly: Phthalate Free, BPA Free, Formaldehyde Free and Lead Free. Fully compliant with all major flammability requirements such California TB 117, NFPA 260 and FMVSS 302.
- Glossy Glaze Collection:
  - Features beautiful, smooth and semi-glossy leather grain pattern. Excellent performance commercial grade-vinyl with 100,000 double rubs.
  - Phthalate free and Lead free. It is California TB 117 fire code certified.
  - Common applications id in hospitality, healthcare, contract, education, marine and automotive industries.
  - All modular components are fully assembled.
  - Dimensions per bench as pictured:
    - Length: 48" by 96" by 48"
    - Depth: 24"
    - Seating Depth: 20"
    - Seating Height: 19"



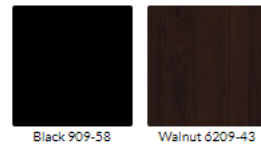

## Model: JMS-Shiraz

- The 21" depth seating surface allows for ample seating space and comfort. This product was designed to occupy the least amount of space while providing the maximum amount of seating.
- Upholstery:
  - Performance commercial grade-vinyl features an abrasion resistance of 500,000 double rub.
  - The Quick Ship Performance vinyl is also Phthalate free and Lead free. It is California TB 117 fire code certified.
  - Common applications id in hospitality, healthcare, contract, education, marine and automotive industries.
- Frame is made from solid wood. Cushions are made of high density CAL 117 certified foam. Joints are glued, stapled and screwed to ensure frame stability and longevity.
- The Black or Walnut premium Formica wrap around the 2" back and base creates a beautiful and luxurious look. Laminate features fire resistance Grade 32 / 50. Stain, scratch and impact resistant under normal use conditions.
- 4" metal black powder coated heavy-duty legs.
- Fully assembled and ready to use (just install legs).
- Dimensions:
  - Length 48" or 60"
  - Width 23" (Single), 46" (Double)
  - Height 40.5"
  - Seating Depth 21"
  - Seating Height 19.5"



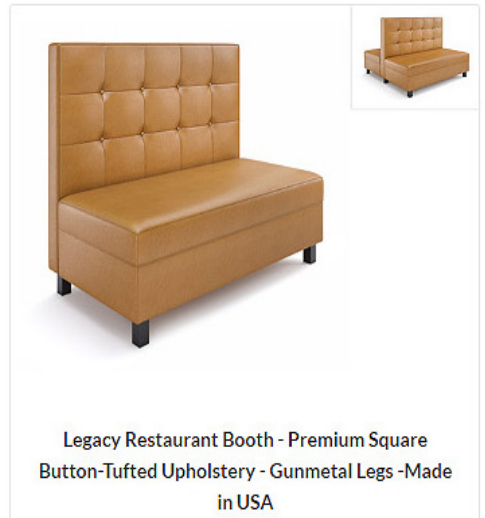
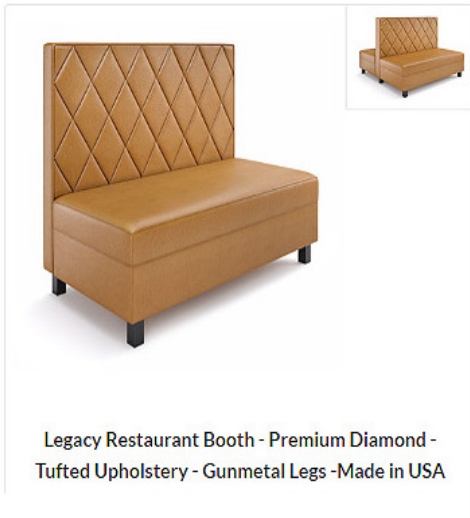
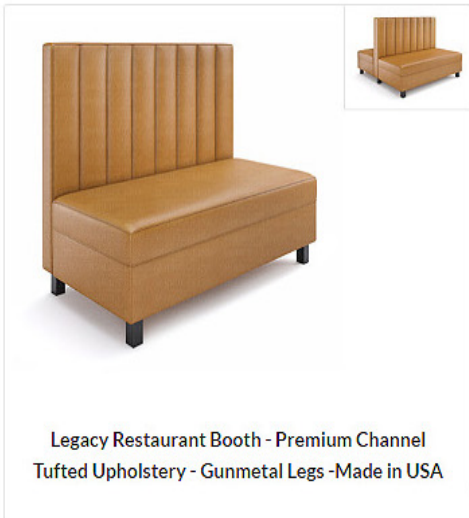

**Model: JMS-Legacy**

- An exclusive banquette booth with a beautiful modern design.
- Exclusive space efficient design which allows you to capitalize on your available space while providing the most seating capacity.
- Built to be sturdy, pieces can be transported with ease and used in high traffic areas
- Upholstered banquette seating with deep soft cushioned padding for the most comfort and support
- Frame is made from solid wood. Cushions are made of high density CAL 117 certified foam. Joints are glued, stapled and screwed to ensure frame stability and longevity.
- Booth sits on elegant gunmetal-finished square metal legs
- Fully assembled and ready to use (just install legs).
- Modular designs are available - see products.
- Handcrafted in USA.
- Classic Super Performance Upholstery:
- The fabrics are handcrafted to withstand the rigorous demands of commercial interiors within restaurants, nightclubs, education, hospitali-ty, corporate, and healthcare environments.
- How it feels: soft and supple hand with a true leather-pattern and texture. Performance specifications: Abrasion resistance contract-grade 500,000 double rubs. Enhanced stain resistance with a liquid barrier.
- Environmentally friendly: Phthalate Free, BPA Free, Formaldehyde Free and Lead Free. Fully compliant with all major flammability re-quirements such California TB 117, NFPA 260 and FMVSS 302.
- Dimensions:
- Length 48” or 60”
- Width 22” (Double 41”)
- Height 42”
- Seating Depth 19”
- Seating Height 18”





## Model: JMS-Expo

- Exclusive space efficient design which allows you to capitalize on your available space while providing the most seating capacity.
- Built to be sturdy, pieces can be transported with ease and used in high traffic areas
- Upholstered banquette seating with deep soft cushioned padding for the most comfort and support
- Frame is made from solid wood. Cushions are made of high density CAL 117 certified foam. Joints are glued, stapled and screwed to ensure frame stability and longevity.
- The premium Formica wrap around the back and base creates a beautiful and luxurious look. Laminate features fire resistance Grade 32 / 50. Stain, scratch and impact resistant under normal use conditions.
- Fully assembled and ready to use.
- Upholstery options:
  - Symphony Collection Classic: The supple hand and texture of pebble grain leather with Resilience-SR protection. Super high-performance commercial grade-vinyl featuring 500,000 double rubs, California and Boston fire codes certifications. Common applications in hospitality, healthcare, contract, education, marine and automotive industries.
  - Glossy Glaze Collection: Features beautiful, smooth and semi-glossy leather grain pattern. Excellent performance commercial grade-vinyl with 100,000 double rubs. Phthalate free and Lead free. It is California TB 117 fire code certified. Common applications id in hospitality, healthcare, contract, education, marine and automotive industries.
- Dimensions:
  - Length 48" or 60"
  - Width 24" (Single), 46" (Double)
  - Height 36"
  - Seating Depth 19"
  - Laminated Base Depth: 18"
  - Seating Height 18"





Luxury Booth - Made in USA



Luxury Vertical Channel Booth - Made in USA



Luxury Diamond Tufted Booth - Made in USA



## Model: JMS-Polk

- Polk luxury booth provides perfect contemporary seating solutions for public spaces in your high traffic environment.
- Upholstery: The supple hand and texture of grain leather. Performance commercial grade-vinyl featuring 500,000 double rubs, California and Boston fire codes certifications. Common applications in hospitality, healthcare, contract, education, marine and automotive industries.
- Carbon steel frame is fully welded with gunmetal powder coated finish.
- Handcrafted in USA.
- Fully assembled and ready to use.
- Dimensions:
- Length: 48", 60" or 73"
- Depth: 27"
- Height: 36"
- Seating Height 18"
- Seating Depth: 22"
- Optional Partition
- Back Partition creates a perfect privacy (safety compliance) separation that protects your patrons.
- Featuring a laminated finish, this partition is thoroughly protected from heat, moisture and scratches under normal use conditions.
- Premium Quality Materials
- Non-porous Surfaces
- Easily Cleaned and Disinfected 100% Customizable
- Made for Hotels, Restaurants, Offices, Events and Public Spaces
- 100% Handcrafted in New Jersey
- Dimensions: 48" x 48" x 1"

Optional laminated privacy partitions are available.







## Model: JMS-Sanremo

- Contrast of curved features and clean lines will give your establishment or event a sleek, contemporary look
- Exclusive space efficient design which allows you to capitalize on your available space while providing the most seating capacity.
- Upholstery Classic Performance:
- The fabrics are handcrafted to withstand the rigorous demands of commercial interiors within restaurants, nightclubs, education, hospitality, corporate, and healthcare environments.
- How it feels: soft and supple hand with a true leather-pattern and texture.
- Performance specifications: Abrasion resistance contract-grade 500,000 double rubs. Enhanced stain resistance with a liquid barrier.
- Environmentally friendly: Phthalate Free, BPA Free, Formaldehyde Free and Lead Free. Fully compliant with all major flammability requirements such California TB 117, NFPA 260 and FMVSS 302.
- Care & Cleaning: Prompt cleaning is always recommended. Clean the soiled area with mild soap and water, then rinse with fresh water and wipe down with a clean cloth.
- Base sits on 4" metal legs.
- Fully assembled and ready to use (just install legs).
- Handcrafted in USA.
- Dimensions:
- Length 48" or 60"
- Width 23" (Single), 46" (Double)
- Height 42"
- Seating Depth 19"
- Seating Height 18"



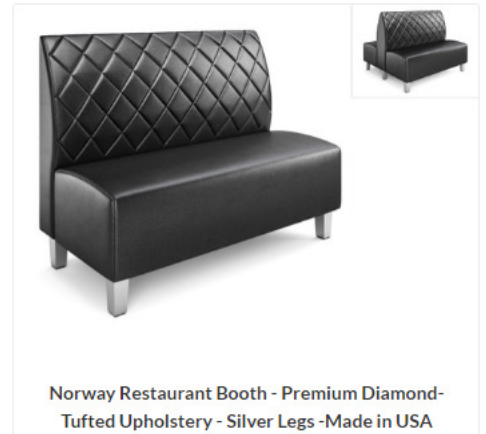
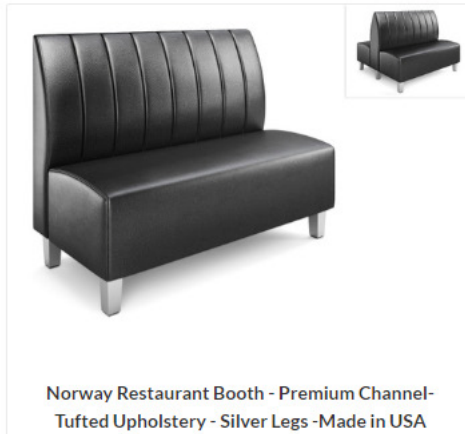
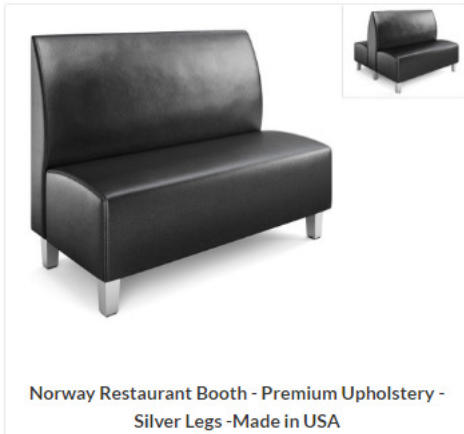

JMS-



## Model: JMS-Norway

- A very unique banquette booth with a beautiful modern design.
- Contrast of curved features and clean lines will give your establishment or event a sleek, contemporary look
- Exclusive space efficient design which allows you to capitalize on your available space while providing the most seating capacity.
- Built to be sturdy, pieces can be transported with ease and used in high traffic areas
- Upholstered banquette seating with deep soft cushioned padding for the most comfort and support
- Frame is made from solid wood. Cushions are made of high density CAL 117 certified foam. Joints are glued, stapled and screwed to ensure frame stability and longevity.
- Booth sits on elegant silver 7" solid wood legs.
- Fully assembled and ready to use (just install legs).
- Upholstery options:
  - Symphony Collection Classic: The supple hand and texture of pebble grain leather with Resilience-SR protection. Super high-performance commercial grade-vinyl featuring 500,000 double rubs, California and Boston fire codes certifications. Common applications in hospitality, healthcare, contract, education, marine and automotive industries.
  - Glossy Glaze Collection: Features beautiful, smooth and semi-glossy leather grain pattern. Excellent performance commercial grade-vinyl with 100,000 double rubs. Phthalate free and Lead free. It is California TB 117 fire code certified. Common applications id in hospitality, healthcare, contract, education, marine and automotive industries.
  - Customer own material options are available

- Dimensions:
  - Length 48" or 60"
  - Width 24.5" (Single), 48" (Double)
  - Height 36"
  - Seating Depth 19"
  - Seating Height 18"

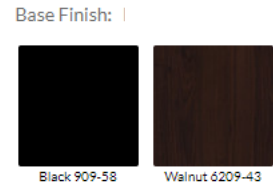
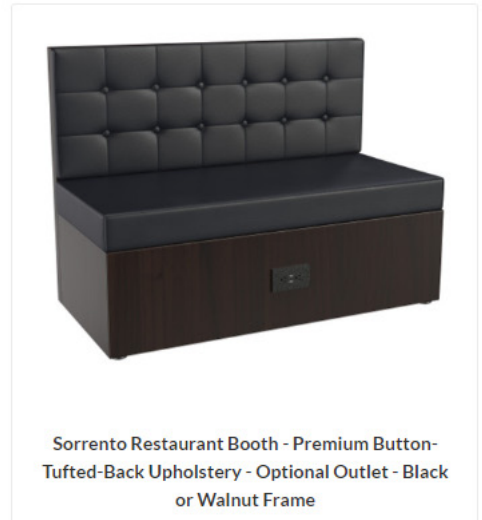
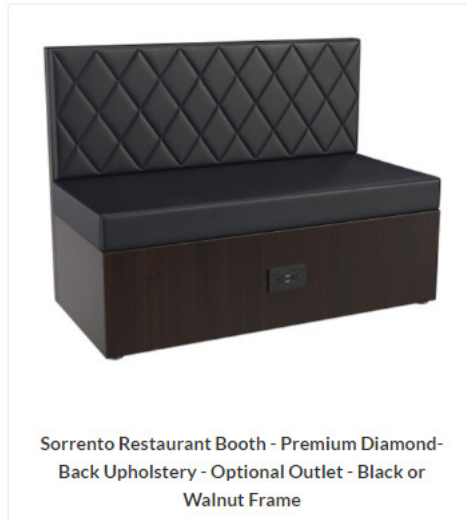
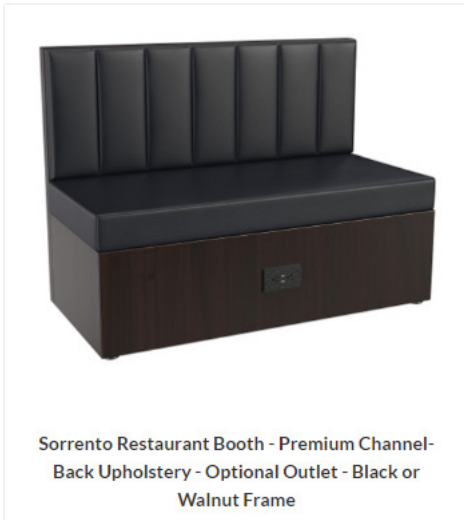

## Model: JMS-Sorrento

- Built to be sturdy, pieces can be transported with ease and used in high traffic areas
- Frame is made from solid wood. Cushions are made of high density CAL 117 certified foam. Joints are glued, stapled and screwed to ensure frame stability and longevity.
- The premium Formica wrap around the back and base creates a beautiful and luxurious look. Laminate features fire resistance Grade 32 / 50. Stain, scratch and impact resistant under normal use conditions.
- Optional power outlet features 2x 110v and 2x USB ports. Please note the outlet is installed at the center of the base.
- Handcrafted in USA by Modern Line Furniture®
- Fully assembled and ready to use.
- Black Upholstery:
  - The supple hand and texture of pebble grain leather with Resilience-SR protection. Super high-performance commercial grade-vinyl featuring 500,000 double rubs, California and Boston fire codes certifications. Common applications in hospitality, healthcare, contract, education, marine and automotive industries.
- Dimensions:
  - Length 48"
  - Width 21"
  - Height 38"
  - Seating Depth 19"
  - Seating Height 18"



Restaurant 3/4 Circle Booth Seating - Contract Grade - Premium Performance Upholstery - 100% Handcrafted In USA



Restaurant 3/4 Circle Booth Seating - Contract Grade - Premium Performance Channel Tufted Upholstery - 100% Handcrafted In USA



Restaurant 3/4 Circle Booth Seating - Contract Grade - Premium Performance Diamond Tufted Upholstery - 100% Handcrafted In USA

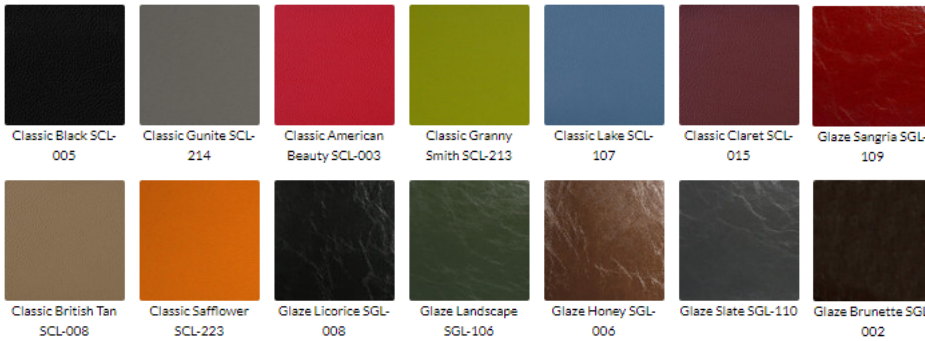

## Model: JMS-Booth-34-Circle

- We offer the ability to manufacture a precise product in any size, shape, length, width, seating depth, seating height, overall height and in any material to create your perfect custom product.
- The 19" depth seating surface allows for ample seating space and comfort. This product was designed to occupy the least amount of space while providing the maximum amount of seating.
- All modular components are fully assembled and ready to use.
- Dimensions per bench as pictured:
  - Length: 48" by 96" by 96" by 48"
  - Depth: 24"
  - Seating Depth: 19"
  - Seating Height: 19"
  - Overall Height: 36"
- Pictured configuration seats up to 6 guests very comfortably.

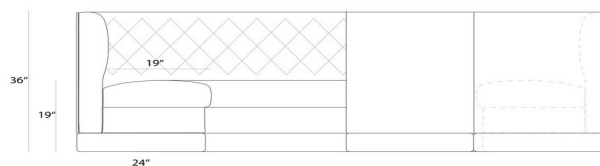
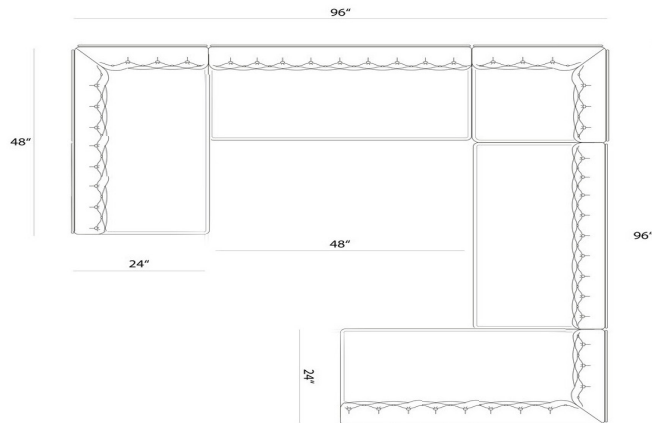



## Model: JMS-Booth-Style-S

- Versatile modular collection Style-S, designed for a modern restaurant to add beauty and luxury to your dining space.
- Configuration shown is standard size of 86"x 106"x 86". We offer the ability to manufacture a precise product in any size, shape, length, width, seating depth, seating height, overall height and in any material to create your perfect custom product.
- All modular components are fully assembled and ready to use.
- Dimensions (Please note this item can be build to your exact specifications, contact us):
  - Overall outside perimeter as pictured: 86" by 106" by 86"
  - Extension with Left or Right Curved Seat: L 44" | D 25" | H 36"
  - Short Extension: L 22" | D 25" | H 36"
  - Corner: L 42" | D 42" | H 36"
  - Seating Depth 20"
  - Seat Height 17.5"
  - Optional Restaurant Table: 56" x 60" (Seats 7 in booth, or 9 with two chairs outside)
- This style can be produced in any custom sizes and in any vinyl/fabric/wood color. We can work with COM (customer own material). Please contact us for a quote.

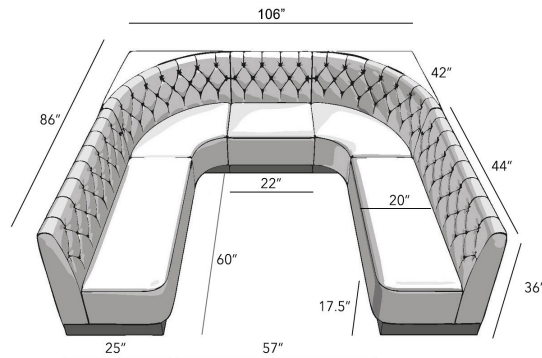

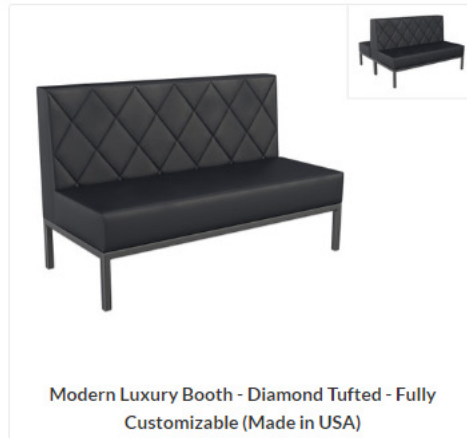
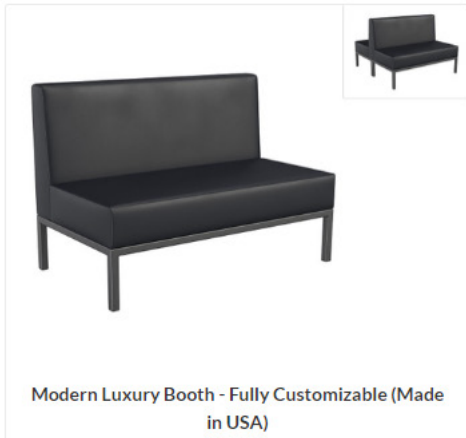

## Model: JMS-Booth-Style-M

- This product is custom made to match your specs or reupholstered in a variety of colors and textures.
- This product was designed to occupy the least amount of space while providing the maximum amount of seating.
- Built to be both lightweight and sturdy, can be transported with ease and used in high traffic areas.
- Durable construction materials include carbon steel frame with fully welded joint assembly with a gunmetal powder coated finish, high density foam 1830-1850, durable decron and heavy gauge steel.
- Fully assembled and ready to use.
- Upholstery:
  - A beautifully leather-textured performance vinyl with abrasion resistance of 500,000 doubles rubs.
  - Phthalate free and Lead free. It is California TB 117 fire code certified.
  - Common applications id in hospitality, healthcare, contract, education, marine and automotive industries.
  - Customer own material options are available. Please contact us.
  - Length 27", 48", 60" or 73"
  - Width 27" (Single), 54" (Double)
  - Height 36"
  - Seating Height 18"
  - Seating Depth 22"





## Model: JMS-Booth-Style-I

- The 19" depth seating surface allows for ample seating space and comfort. This product was designed to occupy the least amount of space while providing the maximum amount of seating.
- Upholstery:
  - High-performance commercial grade-vinyl.
  - Phthalate free and Lead free. It is California TB 117 fire code certified.
  - Common applications id in hospitality, healthcare, contract, education, marine and automotive industries.
- Frame is made from solid wood. Cushions are made of high density CAL 117 certified foam. Joints are glued, stapled and screwed to ensure frame stability and longevity.
- The Black or Walnut premium Formica wrap around the 2" back and base creates a beautiful and luxurious look. Laminate features fire resistance Grade 32 / 50. Stain, scratch and impact resistant under normal use conditions.
- Fully assembled and ready to use.
- Dimensions:
  - Length 48"
  - Width 21" (Single), 42" (Double)
  - Height 48"
  - Seating Depth 19"
  - Seating Height 18"

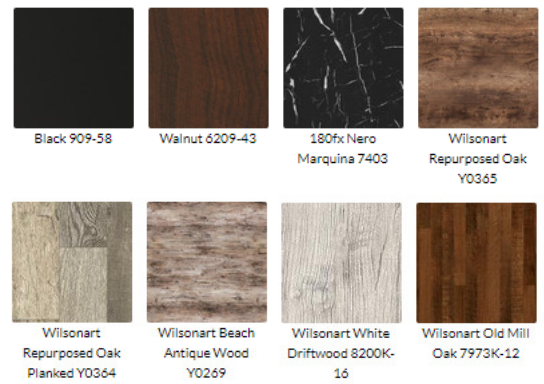
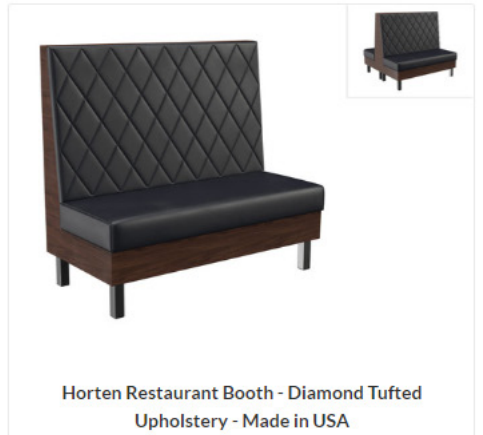
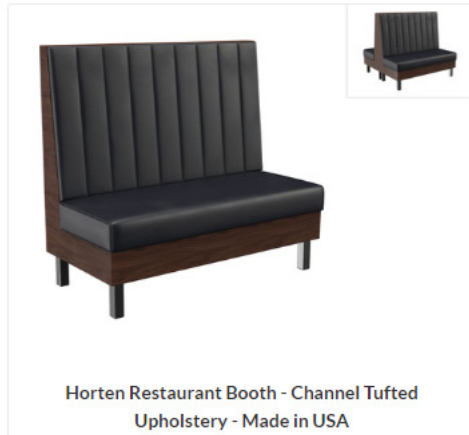

## Model: JMS-Horten

- Luxurious and handmade Horten Tall Restaurant Booth will give your restaurant an exclusive design with commercial grade quality.
- Featuring a premium laminated finish, this booth's frame is thoroughly protected from heat, moisture and scratches.
- Upholstery:
  - High-performance commercial grade-vinyl features an abrasion resistance of 500,000 double rubs, which is approximately 5-10 times more than any chair on the market.
  - Phthalate free and Lead free. It is California TB 117 fire code certified.
  - Common applications id in hospitality, healthcare, contract, education, marine and automotive industries.
- Frame is made from solid wood. Cushions are made of high density CAL 117 certified foam. Joints are glued, stapled and screwed to ensure frame stability and longevity.
- The 18" seating surface of this model is designed to fit any space while offering you and your guests maximum comfort.
- 4" metal black powder coated heavy-duty legs.
- Fully assembled and ready to use (just install legs).
- Dimensions:
  - Length 48"
  - Depth Single Booth 26" | Depth Double Booth 52"
  - Height 48"
  - Seating Depth 21"
  - Seating Height 19.5"





- Length 42"
- Depth 25.5"
- Height 38"
- Seating Depth 21"
- Seating Height 18"



- Length 42"
- Depth 48"
- Height 38"
- Seating Depth 21"
- Seating Height 18"



## Model: JMS-9038

- One of our most popular modular lounge seating with only three components to create many seating configurations.
- Upholstery options:
  - Classic Super Performance:
    - The fabrics are handcrafted to withstand the rigorous demands of commercial interiors within restaurants, nightclubs, education, hospitality, corporate, and healthcare environments.
    - How it feels: soft and supple hand with a true leather-pattern and texture. Performance specifications: Abrasion resistance contract-grade 500,000 double rubs. Enhanced stain resistance with a liquid barrier.
    - Environmentally friendly: Phthalate Free, BPA Free, Formaldehyde Free and Lead Free. Fully compliant with all major flammability requirements such California TB 117, NFPA 260 and FMVSS 302.
    - Care & Cleaning: Prompt cleaning is always recommended. Clean the soiled area with mild soap and water, then rinse with fresh water and wipe down with a clean cloth.
  - Glossy Glaze Collection:
    - Features beautiful, smooth and semi-glossy leather grain pattern. Excellent performance commercial grade-vinyl with 100,000 double rubs.
    - Phthalate free and Lead free. It is California TB 117 fire code certified.
    - Common applications id in hospitality, healthcare, contract, education, marine and automotive industries.
- The 21" depth seating surface allows for ample seating space and comfort. This product was designed to occupy the least amount of space while providing the maximum amount of seating.
- Built to be both lightweight and sturdy, pieces can be transported with ease and used in high traffic areas.
- Frame is built of solid hardwood. Cushion is made of high density CAL 117 certified foam. Joints are glued, stapled and screwed to ensure frame stability and longevity.
- Base sits on metal base glides



- Length 42"
- Depth 25.5"
- Height 52"
- Seating Depth 21"
- Seating Height 18"



- Length 42"
- Depth 48"
- Height 52"
- Seating Depth 21"
- Seating Height 18"

**Model: JMS-9050Z-Booth**



Our furniture is designed and manufactured for use in high traffic public areas.





**Upholstery:**  
Classic Black SCL-005  
**Base Finish:**  
Formica Walnut 6209-43



**Upholstery:**  
Classic Black SCL-005  
**Base Finish:**  
Formica Black 909-58



**Upholstery:**  
Classic Black SCL-005  
**Base Finish:**  
Formica Walnut 6209-43

## Model: JMS-Booth-Lam-Box-Tuft

- The 21" depth seating surface allows for ample seating space and comfort. This product was designed to occupy the least amount of space while providing the maximum amount of seating.
- Upholstery is Quick Ship Performance: The supple hand and texture of grain leather. Performance commercial grade-vinyl featuring 50,000 double rubs, California and Boston fire codes certifications. Common applications in hospitality, healthcare, contract, education, marine and automotive industries.
- Frame is made from solid wood. Cushions are made of high density CAL 117 certified foam. Joints are glued, stapled and screwed to ensure frame stability and longevity.
- The premium Formica wrap around the 2" back and base creates a beautiful and luxurious look. Laminate features fire resistance Grade 32 / 50. Stain, scratch and impact resistant under normal use conditions.
- Optional power outlet features 2x 110v and 2x USB ports. Please note the outlet is installed at the center of the base.
- Dimensions:
  - Overall Length 48" or 65"
  - Width 21" (Single), 44" (Double)"
  - Height 48"
  - Seating Depth 21"
  - Seating Height 20"
  - Each Back Upholstered Panel measures 19" by 26".



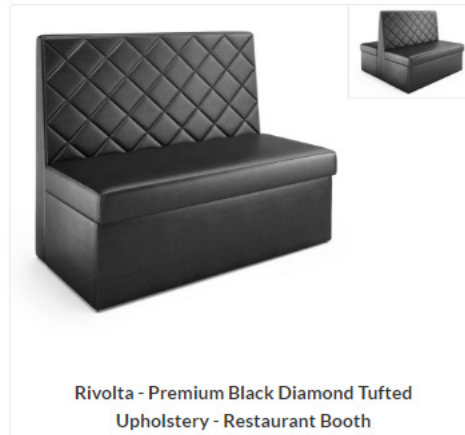

## Model: JMS-Rivolta

- An exclusive banquette booth with a beautiful modern back panel.
- Exclusive space efficient design which allows you to capitalize on your available space while providing the most seating capacity.
- Built to be sturdy, pieces can be transported with ease and used in high traffic areas
- Upholstered banquette seating with deep soft cushioned padding for the most comfort and support
- Frame is made from solid wood. Cushions are made of high density CAL 117 certified foam. Joints are glued, stapled and screwed to ensure frame stability and longevity
- Booth sits on metal glides.
- Fully assembled and ready to use (just install legs).
- Classic Super Performance Upholstery:
  - The fabrics are handcrafted to withstand the rigorous demands of commercial interiors within restaurants, nightclubs, education, hospitality, corporate, and healthcare environments.
  - How it feels: soft and supple hand with a true leather-pattern and texture. Performance specifications: Abrasion resistance contract-grade 500,000 double rubs. Enhanced stain resistance with a liquid barrier.
  - Environmentally friendly: Phthalate Free, BPA Free, Formaldehyde Free and Lead Free. Fully compliant with all major flammability requirements such California TB 117, NFPA 260 and FMVSS 302.
  - Care & Cleaning: Prompt cleaning is always recommended. Clean the soiled area with mild soap and water, then rinse with fresh water and wipe down with a clean cloth.

- Length 48"
- Width 25" (Double 48")
- Height 38"
- Seating Depth 21"
- Seating Height 17"



Frame: Walnut



Frame: Walnut



Frame: Walnut

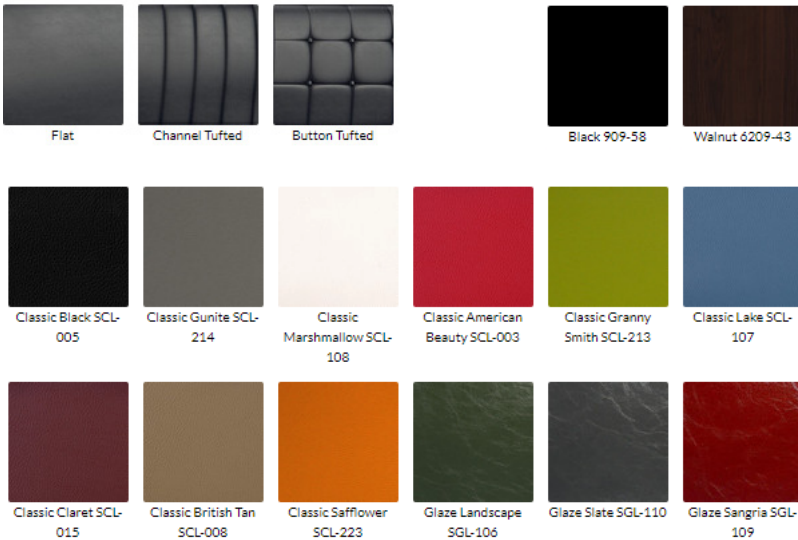

## Model: JMS-Booth-Bar-Height

- This product is custom made to match your specs or reupholstered in a variety of colors and textures.
- The 19" depth seating surface allows for ample seating space and comfort. This product was designed to occupy the least amount of space while providing the maximum amount of seating.
- Built to be very sturdy, can be transported with ease and used in high traffic areas.
- Durable construction materials include solid hardwood frames build from 2"x3" heavy duty studs, high density foam 1830-1850, durable decron and heavy gauge steel.
- Frame is built of solid hardwood. Cushion is made of high density CAL 117 certified foam and Leggett & Platt No-Sag® springs. Joints are glued, stapled and screwed to ensure frame stability and longevity.
- Footrest features a stainless steel panel for feet support.
- Fully assembled and ready to use.
- Dimensions
  - Length (side to side) 48"
  - Height (floor to top) 60"
  - Height Step (floor to step) 12"
  - Width 30"
  - Seating Depth 19"
  - Seating Height (from step to seat top) 19"



## Model: JMS-1831

- The contemporary aesthetics of this gorgeous chair marries an elegant dark walnut solid-wood frame with high performance exquisite blends of upholstery options.
- Chair is made from premium-grade rubberwood - an environmentally friendly tropical hardwood.
- Chair's frame color is Espresso with a 30% gloss finish
- All joints are glued, screwed, and connected by mortise and big tenon.
- Comfortable seat cushion is made from high-quality CAL 117 high density foam.
- Upholstery:
  - Performance commercial grade-vinyl. Phthalate free and Lead free. It is California TB 117 fire code certified.
  - Common applications id in hospitality, healthcare, contract, education, marine and automotive industries.
- Dimensions:
  - Width: 22.5"
  - Depth: 23"
  - Height: 30"
  - Seating Height: 18.5"
  - Seat 18" x 19"



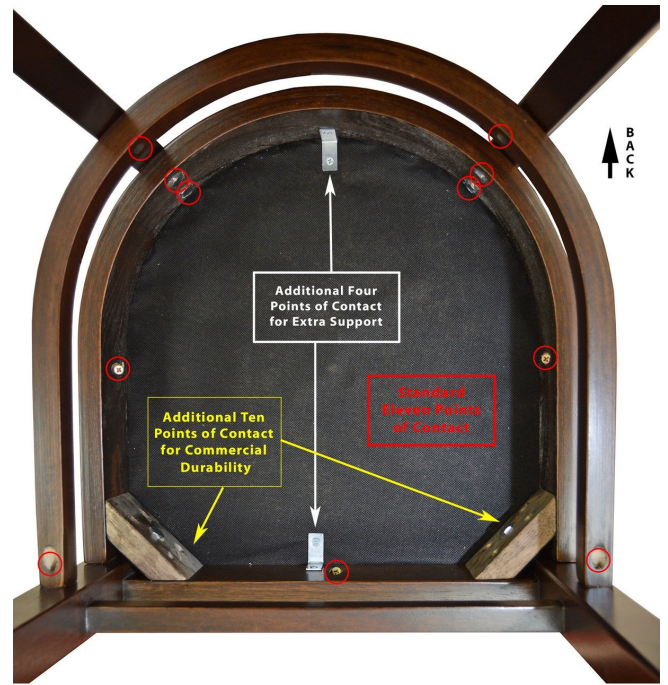

## Model: JMS-6101DC

- Chair is made from premium-grade rubberwood - an environmentally friendly tropical hardwood.
- Chair's frame color is Espresso with a 30% gloss finish
- All joints are glued, screwed, and connected by mortise and big tenon.
- Solid wood corner blocks, secured by two wood bolts and eight wood screws, distribute pressure throughout frame.
- Comfortable seat cushion is made from high-quality CAL 117 26 density foam.
- Upholstery:
  - A beautifully leather-textured performance vinyl with abrasion resistance of 500,000 doubles rubs.
  - Phthalate free and Lead free. It is California TB 117 fire code certified.
  - Common applications id in hospitality, healthcare, contract, education, marine and automotive industries.
- Dimensions:
  - Overall Width: 17"
  - Overall Depth: 21.75'
  - Overall Height: 34"
  - Seating Height: 19.5"
  - Seat: 17" W x 16.7" D
  - Product Weight: 13 lbs
  - Weight Capacity: 350 lbs

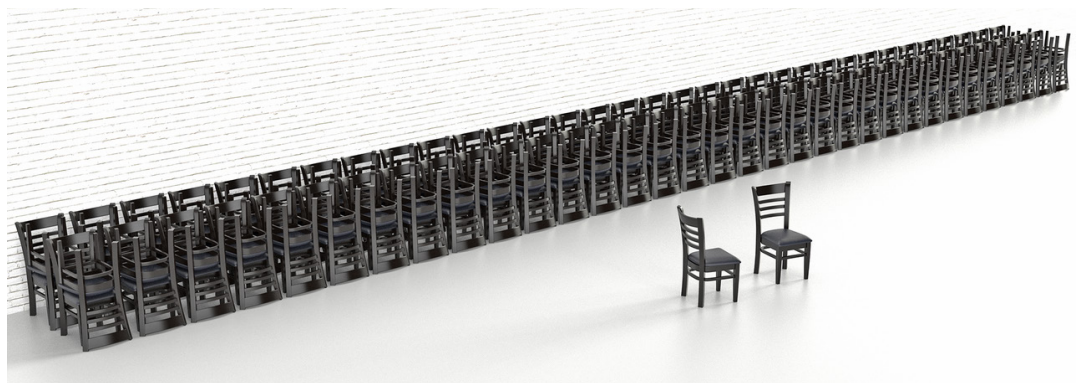



## Model: JMS-6101BS

- Bar stools is made from premium-grade rubberwood - an environmentally friendly tropical hardwood.
- Bar stool's frame color is Espresso with a 30% gloss finish
- All joints are glued, screwed, and connected by mortise and big tenon.
- Solid wood corner blocks, secured by two wood bolts and eight wood screws, distribute pressure throughout frame.
- Comfortable seat cushion is made from high-quality CAL 117 26 density foam.
- Upholstery:
  - A beautiful leather-textured performance vinyl with abrasion resistance of 500,000 doubles rubs.
  - Phthalate free and Lead free. It is California TB 117 fire code certified.
  - Common applications id in hospitality, healthcare, contract, education, marine and automotive industries.
- Dimensions:
  - Overall Width: 17"
  - Overall Depth: 21"
  - Overall Height: 43"
  - Seating Height: 32"
  - Seat: 17" W x 16.7" D



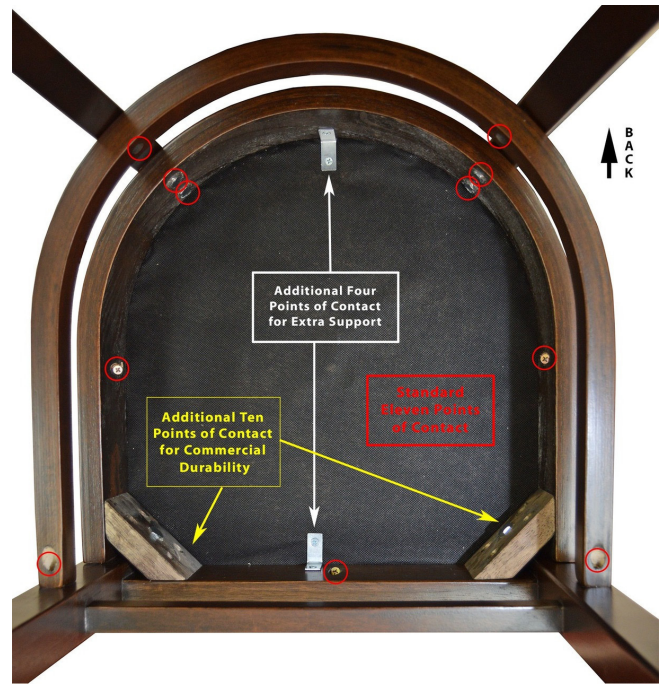

## Model: JMS-6102DC

- Chair is made from premium-grade rubberwood - an environmentally friendly tropical hardwood.
- Chair's frame color is Espresso with a 30% gloss finish
- All joints are glued, screwed, and connected by mortise and big tenon.
- Solid wood corner blocks, secured by two wood bolts and eight wood screws, distribute pressure throughout frame.
- Comfortable seat cushion is made from high-quality CAL 117 26 density foam.
- Upholstery:
  - A beautifully leather-textured performance vinyl with abrasion resistance of 500,000 doubles rubs.
  - Phthalate free and Lead free. It is California TB 117 fire code certified.
  - Common applications id in hospitality, healthcare, contract, education, marine and automotive industries.
- Dimensions:
  - Overall Width: 17"
  - Overall Depth: 21.75'
  - Overall Height: 34"
  - Seating Height: 19.5"
  - Seat: 17" W x 16.7" D
  - Product Weight: 13 lbs
  - Weight Capacity: 350 lbs





## Model: JMS-6102BS

- Bar stools is made from premium-grade rubberwood - an environmentally friendly tropical hardwood.
- Bar stool's frame color is Espresso with a 30% gloss finish
- All joints are glued, screwed, and connected by mortise and big tenon.
- Solid wood corner blocks, secured by two wood bolts and eight wood screws, distribute pressure throughout frame.
- Comfortable seat cushion is made from high-quality CAL 117 26 density foam.
- Upholstery:
  - A beautiful leather-textured performance vinyl with abrasion resistance of 500,000 doubles rubs.
  - Phthalate free and Lead free. It is California TB 117 fire code certified.
  - Common applications id in hospitality, healthcare, contract, education, marine and automotive industries.
- Dimensions:
  - Overall Width: 17"
  - Overall Depth: 21"
  - Overall Height: 43"
  - Seating Height: 32"
  - Seat: 17" W x 16.7" D

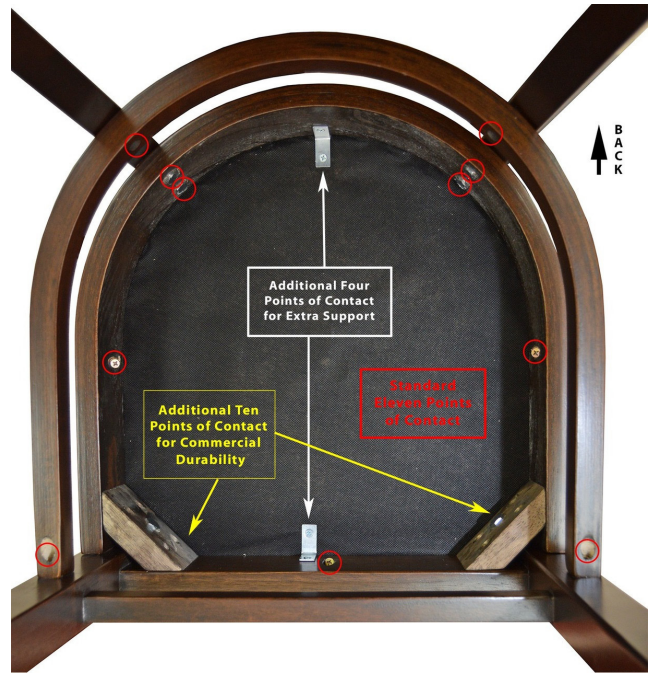

**Model: JMS-6105DC**

- Chair is made from premium-grade rubberwood - an environmentally friendly tropical hardwood.
- Chair's frame color is Espresso with a 30% gloss finish
- All joints are glued, screwed, and connected by mortise and big tenon.
- Solid wood corner blocks, secured by two wood bolts and eight wood screws, distribute pressure throughout frame.
- Comfortable seat cushion is made from high-quality CAL 117 26 density foam.
- Upholstery:
  - A beautifully leather-textured performance vinyl with abrasion resistance of 500,000 doubles rubs.
  - Phthalate free and Lead free. It is California TB 117 fire code certified.
  - Common applications id in hospitality, healthcare, contract, education, marine and automotive industries.
- Dimensions:
  - Overall Width: 17"
  - Overall Depth: 21.75"
  - Overall Height: 34"
  - Seating Height: 19.5"
  - Seat: 17" W x 16.7" D





## Model: JMS-6105BS

- The bar stools is made from premium-grade solid wood. All joints are glued, screwed, and connected by mortise and big tenon.
- Durable construction materials include solid hardwood frames, high density foam and commercial-grade vinyl.
- Solid wood corner blocks, secured by two wood bolts and eight wood screws, distribute pressure throughout frame.
- Built to be both lightweight and sturdy, designed to be transported with ease and used in high traffic areas.
- Upholstery:
  - A beautifully leather-textured performance vinyl with abrasion resistance of 500,000 doubles rubs.
  - Phthalate free and Lead free. It is California TB 117 fire code certified.
  - Common applications id in hospitality, healthcare, contract, education, marine and automotive industries.
- Dimensions:
  - Overall Width: 17"
  - Overall Depth: 21"
  - Overall Height: 43"
  - Seating Height: 32"
  - Seat: 17" W x 16.7" D





## Model: JMS-LUIS-DC

- This product is immediately available in standard white and black colors. This product can be reupholstered in a variety of colors and textures within a few business days.
- This luxurious restaurant chair was designed with comfort in mind - the curvy back with a beautifully upholstered deep cushy seating will be a perfect addition to your restaurant or venue.
- Built to be both lightweight and sturdy, designed to be transported with ease and used in high traffic areas.
- The chair is made from solid premium-grade hardwood built with comfort and support in mind. All joints are glued, screwed, and connected by mortise and big tenon. The generously padded seating is made with high density foam and commercial-grade vinyl.
- Upholstery is high-performance commercial grade-vinyl, California and Boston fire codes certifications. Common applications in hospitality, healthcare, contract, education, marine and automotive industries.
- Dimensions:
  - Overall Width: 17"
  - Overall Depth: 21"
  - Overall Height: 34"



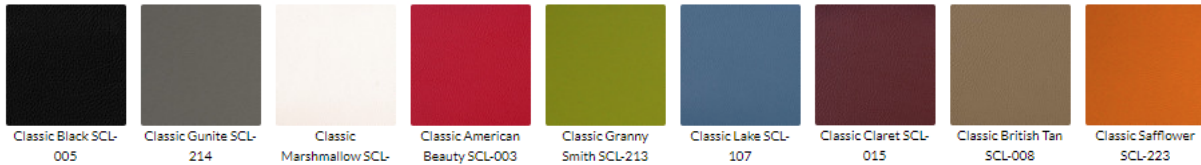

## Model: JMS-LUIS-BS

- This product is immediately available in standard white and black colors. This product can be reupholstered in a variety of colors and textures within a few business days.
- This luxurious bar stool was designed with comfort in mind - the curvy back with a beautifully upholstered deep cushy seating will be a perfect addition to your restaurant or venue.
- Built to be both lightweight and sturdy, designed to be transported with ease and used in high traffic areas.
- The bar stool is made from solid premium-grade hardwood built with comfort and support in mind. All joints are glued, screwed, and connected by mortise and big tenon. The generously padded seating is made with high density foam and commercial-grade vinyl.
- Aluminum bar foot rest.
- Dimensions: H 43.7" | W 17" | D 16" | Seating Height 29.5"





## Model: JMS-HENRY-DC

- Chair is made from premium-grade rubberwood - an environmentally friendly tropical hardwood.
- Chair's frame color is Walnut with a 30% gloss finish
- All joints are glued, screwed, and connected by mortise and big tenon.
- Solid wood corner blocks, secured by two wood bolts and eight wood screws, distribute pressure throughout frame.
- Comfortable seat cushion is made from high-quality CAL 117 26 density foam.
- Upholstery options:
  - Symphony Collection Classic: The supple hand and texture of pebble grain leather with Resilience-SR protection. Super high-performance commercial grade-vinyl featuring 500,000 double rubs, California and Boston fire codes certifications. Common applications in hospitality, healthcare, contract, education, marine and automotive industries.
  - Glossy Glaze Collection: Features beautiful, smooth and semi-glossy leather grain pattern. Excellent performance commercial grade-vinyl with 100,000 double rubs. Phthalate free and Lead free. It is California TB 117 fire code certified. Common applications id in hospitality, healthcare, contract, education, marine and automotive industries.
  - Customer own material options are available
- Dimensions:
  - Overall Width: 17"
  - Overall Depth: 21'
  - Overall Height: 34"

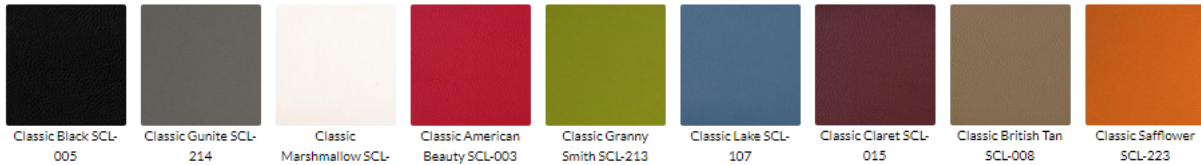

## Model: JMS-HENRY-BS

- Bar stools is made from premium-grade rubberwood - an environmentally friendly tropical hardwood.
- Bar stool's frame color is Walnut with a 30% gloss finish
- All joints are glued, screwed, and connected by mortise and big tenon.
- Solid wood corner blocks, secured by two wood bolts and eight wood screws, distribute pressure throughout frame.
- Comfortable seat cushion is made from high-quality CAL 117 26 density foam.
- Upholstery options:
  - Symphony Collection Classic: The supple hand and texture of pebble grain leather with Resilience-SR protection. Super high-performance commercial grade-vinyl featuring 500,000 double rubs, California and Boston fire codes certifications. Common applications in hospitality, healthcare, contract, education, marine and automotive industries.
  - Glossy Glaze Collection: Features beautiful, smooth and semi-glossy leather grain pattern. Excellent performance commercial grade-vinyl with 100,000 double rubs. Phthalate free and Lead free. It is California TB 117 fire code certified. Common applications id in hospitality, healthcare, contract, education, marine and automotive industries.
  - Customer own material options are available
- Dimensions:
  - Overall Width: 17"
  - Overall Depth: 17"
  - Overall Height: 44"
  - Seating Height: 30"



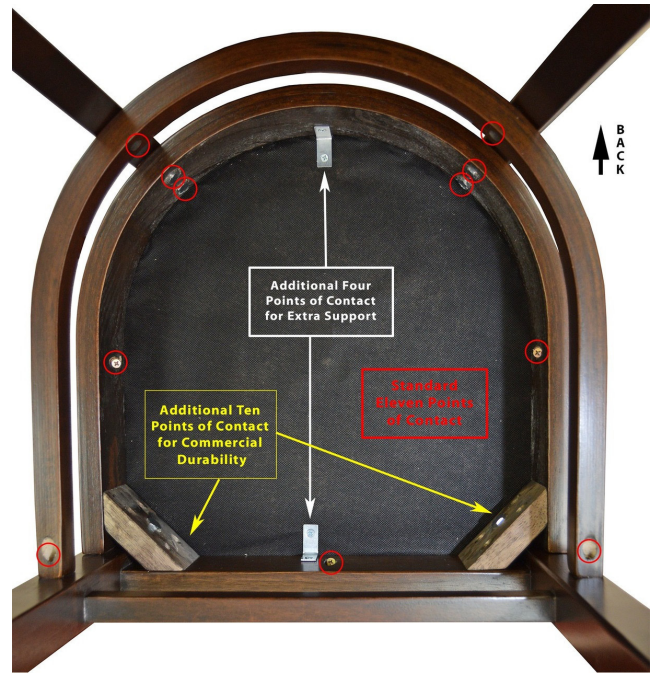

## Model: JMS-6000DC

- Chair is made from premium-grade rubberwood - an environmentally friendly tropical hardwood.
- Chair's frame color is Espresso with a 30% gloss finish
- All joints are glued, screwed, and connected by mortise and big tenon.
- Solid wood corner blocks, secured by two wood bolts and eight wood screws, distribute pressure throughout frame.
- Comfortable seat & back cushion is made from high-quality CAL 117 26 density foam.
- Upholstery:
  - A beautifully leather-textured performance vinyl with abrasion resistance of 500,000 double rubs.
  - Phthalate free and Lead free. It is California TB 117 fire code certified.
  - Common applications in hospitality, healthcare, contract, education, marine and automotive industries.
- Dimensions:
  - Overall Width: 17"
  - Overall Depth: 21.75"
  - Overall Height: 34"
  - Seating Height: 19.5"
  - Seat: 17" W x 16.7" D





## Model: JMS-6000BS

- Bar stools is made from premium-grade rubberwood - an environmentally friendly tropical hardwood.
- Bar stool's frame color is Espresso with a 30% gloss finish
- All joints are glued, screwed, and connected by mortise and big tenon.
- Solid wood corner blocks, secured by two wood bolts and eight wood screws, distribute pressure throughout frame.
- Comfortable seat cushion is made from high-quality CAL 117 26 density foam.
- Upholstery:
  - A beautiful leather-textured performance vinyl with abrasion resistance of 500,000 doubles rubs.
  - Phthalate free and Lead free. It is California TB 117 fire code certified.
  - Common applications id in hospitality, healthcare, contract, education, marine and automotive industries.
- Dimensions:
  - Overall Width: 17"
  - Overall Depth: 21"
  - Overall Height: 43"
  - Seating Height: 32"
  - Seat: 17" W x 16.7" D

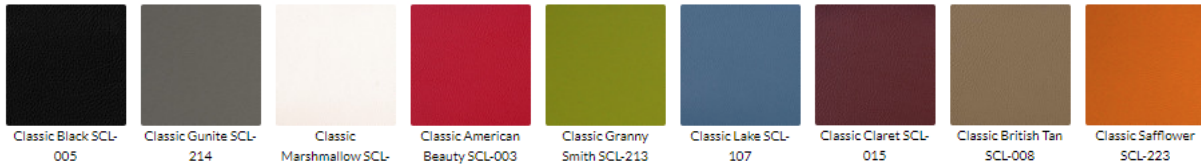

## Model: JMS-CP001TB

- Chair is made from premium-grade rubberwood - an environmentally friendly tropical hardwood.
- Chair's frame color is Espresso with a 30% gloss finish
- All joints are glued, screwed, and connected by mortise and big tenon.
- Solid wood corner blocks, secured by two wood bolts and eight wood screws, distribute pressure throughout frame.
- Comfortable seat cushion is made from high-quality CAL 117 26 density foam.
- Back Panel Upholstery Options:
  - Standard Black is commercial-grade vinyl with CAL 117
  - Common applications id in hospitality, healthcare, contract, education, marine and automotive industries.
- Dimensions:
  - Overall Width: 18.3"
  - Overall Depth: 20"
  - Overall Height: 35.5"
  - Seating Height: 18.5"
  - Seat: 15.7" W x 17.7" D



## Model: JMS-BSP001TB

- Bar stool is made from premium-grade rubberwood - an environmentally friendly tropical hardwood.
- Bar stool's frame color is Espresso with a 30% gloss finish
- All joints are glued, screwed, and connected by mortise and big tenon.
- Solid wood corner blocks, secured by two wood bolts and eight wood screws, distribute pressure throughout frame.
- Comfortable seat cushion is made from high-quality CAL 117 26 density foam.
- Upholstery Options:
  - Standard Black Seat Upholstery is commercial-grade vinyl with CAL 117
  - Common applications id in hospitality, healthcare, contract, education, marine and automotive industries.
- Dimensions:
  - Overall Width: 18.3"
  - Overall Depth: 20"
  - Overall Height: 43.7"
  - Seating Height: 29.5"
  - Seat: 15.7" W x 17.7" D



## Model: JMS-CS6043TB

- Chair is made from premium-grade rubberwood - an environmentally friendly tropical hardwood.
- Chair's frame color is Espresso with a 30% gloss finish
- All joints are glued, screwed, and connected by mortise and big tenon.
- Solid wood corner blocks, secured by two wood bolts and eight wood screws, distribute pressure throughout frame.
- Comfortable seat cushion is made from high-quality CAL 117 26 density foam.
- Upholstery Options:
  - A beautifully leather-textured performance vinyl with abrasion resistance of 50,000 double rubs.
  - Phthalate free and Lead free. It is California TB 117 fire code certified.
  - Common applications include in hospitality, healthcare, contract, education, marine and automotive industries.
- Dimensions:
  - Overall Width: 17"
  - Overall Depth: 21.75"
  - Overall Height: 34"
  - Seating Height: 19.5"
  - Seat: 17" W x 16.7" D



## Model: JMS-BS6043TB

- Bar stool is made from premium-grade rubberwood - an environmentally friendly tropical hardwood.
- Bar Stool's frame color is Espresso with a 30% gloss finish
- All joints are glued, screwed, and connected by mortise and big tenon.
- Solid wood corner blocks, secured by two wood bolts and eight wood screws, distribute pressure throughout frame.
- Comfortable seat cushion is made from high-quality CAL 117 26 density foam.
- Upholstery:
  - A beautifully leather-textured performance vinyl with abrasion resistance of 50,000 double rubs.
  - Phthalate free and Lead free. It is California TB 117 fire code certified.
  - Common applications are in hospitality, healthcare, contract, education, marine and automotive industries.
- Dimensions:
  - Overall Width: 17"
  - Overall Depth: 21"
  - Overall Height: 43"
  - Seating Height: 32"
  - Seat: 17" W x 16.7" D



## Model: JMS-CP0027

- Chair is made from premium-grade rubberwood - an environmentally friendly tropical hardwood.
- Chair's frame color is Espresso with a 30% gloss finish
- All joints are glued, screwed, and connected by mortise and big tenon.
- Solid wood corner blocks, secured by two wood bolts and eight wood screws, distribute pressure throughout frame.
- Comfortable seat cushion is made from high-quality CAL 117 26 density foam.
- Upholstery:
  - A beautifully leather-textured performance vinyl with abrasion resistance of 500,000 doubles rubs.
  - Phthalate free and Lead free. It is California TB 117 fire code certified.
  - Common applications id in hospitality, healthcare, contract, education, marine and automotive industries.
- Dimensions:
  - Overall Width: 20"
  - Overall Depth: 21.75"
  - Overall Height: 34"
  - Seating Height: 18"
  - Seat: 20" W x 17" D

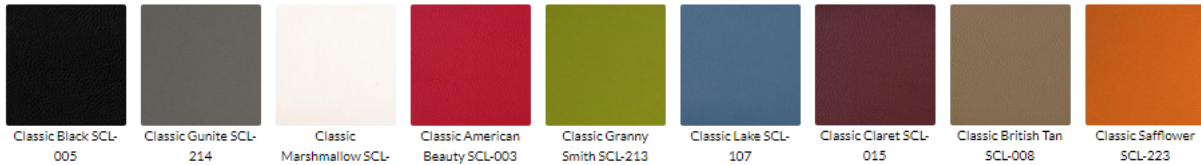

## Model: JMS-PP0027

- Bar stool is made from premium-grade rubberwood - an environmentally friendly tropical hardwood.
- Bar stool's frame color is Espresso with a 30% gloss finish
- All joints are glued, screwed, and connected by mortise and big tenon.
- Solid wood corner blocks, secured by two wood bolts and eight wood screws, distribute pressure throughout frame.
- Comfortable seat cushion is made from high-quality CAL 117 26 density foam.
- Upholstery:
  - A beautifully leather-textured performance vinyl with abrasion resistance of 500,000 double rubs.
  - Phthalate free and Lead free. It is California TB 117 fire code certified.
  - Common applications are in hospitality, healthcare, contract, education, marine and automotive industries.
- Dimensions:
  - Overall Width: 19"
  - Overall Depth: 22"
  - Overall Height: 44"
  - Seating Height: 30"
  - Seat: 20" W x 17" D





## Model: JMS-CP0013

- The chair is made from solid premium-grade wood built with comfort and support in mind. All joints are glued, screwed, and connected by mortise and big tenon.
- Solid wood corner blocks, secured by two wood bolts and eight wood screws, distribute pressure throughout frame.
- Durable construction materials include **solid box seat hardwood frames**, high density foam and commercial-grade vinyl.
- The Classic Super Performance fabrics are handcrafted to withstand the rigorous demands of commercial interiors within restaurants, nightclubs, education, hospitality, corporate, and healthcare environments.
- How it feels: Soft and supple hand with a true leather-pattern and texture. Performance specifications: Abrasion resistance contract-grade 500,000 double rubs. Enhanced stain resistance with a liquid barrier.
- Environmentally friendly: Phthalate Free, BPA Free, Formaldehyde Free and Lead Free. Fully compliant with all major flammability requirements such California TB 117, NFPA 260 and FMVSS 302.
- Upholstery Care & Cleaning: Prompt cleaning is always recommended. Clean the soiled area with mild soap and water, then rinse with fresh water and wipe down with a clean cloth.
- Dimensions:
  - Overall Width: 19.8"
  - Overall Depth: 21"
  - Overall Height: 34.5"
  - Seating Height: 18.5"
  - Seat: 17.7" W x 16.5" D





## Model: JMS-7016

- Chair is made from premium-grade rubberwood - an environmentally friendly tropical hardwood.
- Chair's frame color is Espresso with a 30% gloss finish
- All joints are glued, screwed, and connected by mortise and big tenon.
- Comfortable seat cushion is made from high-quality CAL 117 foam.
- Upholstery Classic Super Performance:
  - The fabrics are handcrafted to withstand the rigorous demands of commercial interiors within restaurants, nightclubs, education, hospitality, corporate, and healthcare environments.
  - How it feels: soft and supple hand with a true leather-pattern and texture. Performance specifications: Abrasion resistance contract-grade 500,000 double rubs. Enhanced stain resistance with a liquid barrier.
  - Environmentally friendly: Phthalate Free, BPA Free, Formaldehyde Free and Lead Free. Fully compliant with all major flammability requirements such California TB 117, NFPA 260 and FMVSS 302.
  - Common applications id in hospitality, healthcare, contract, education, marine and automotive industries.
- Dimensions:
  - Overall Width: 21"
  - Overall Depth: 21"
  - Overall Height: 31"
  - Seating Height: 18.5"
  - Seat: 21" W x 19" D
  - Chair Weight: 16lbs
  - Weight capacity up to 300lbs





## Model: JMS-696DC

- Padded vinyl upholstered back and seat. CA117 fire retardant foam.
- Upholstery:
  - A beautiful leather-textured performance vinyl with abrasion resistance of 500,000 double rubs.
  - Phthalate free and Lead free. It is California TB 117 fire code certified.
  - Common applications include in hospitality, healthcare, contract, education, marine and automotive industries.
- Gunmetal powder coated frame with welded joint assembly
- Plastic floor glides
- Designed for commercial environments.
- Proudly made in America
- Dimensions:
  - Width: 19"
  - Depth: 24"
  - Height: 32"
  - Seat Height: 18"





## Model: JMS-696BS

- Padded vinyl upholstered back and seat. CA117 fire retardant foam.
- Upholstery:
  - A beautifully leather-textured performance vinyl with abrasion resistance of 500,000 double rubs.
  - Phthalate free and Lead free. It is California TB 117 fire code certified.
  - Common applications include in hospitality, healthcare, contract, education, marine and automotive industries.
- Gunmetal powder coated frame with welded joint assembly
- Plastic floor glides
- Designed for commercial environments.
- Proudly made in America
- Dimensions:
  - Width: 19"
  - Depth: 24"
  - Height: 43.5"
  - Seat Height: 30"





## Model: JMS-697DC

- Upholstery is Quick Ship Performance:
  - A supple leather grain high-performance commercial grade vinyl features an abrasion resistance of 500,000 double rubs
  - Phthalate free and Lead free. It is California TB 117 fire code certified.
  - Common applications id in hospitality, healthcare, contract, education, marine and automotive industries.
- Tubular round gunmetal powder coated frame with welded joint assembly
- Plastic floor glides
- Designed for commercial environments.
- Proudly made in America
- Dimensions:
  - Width: 19"
  - Depth: 24"
  - Height: 32"
  - Seat Height: 18"



## Model: JMS-697BS

- Padded vinyl upholstered back and seat. CA117 fire retardant foam.
- Upholstery:
  - A beautifully leather-textured performance vinyl with abrasion resistance of 500,000 double rubs.
  - Phthalate free and Lead free. It is California TB 117 fire code certified.
  - Common applications include in hospitality, healthcare, contract, education, marine and automotive industries.
- Tubular round gunmetal powder coated frame with welded joint assembly
- Plastic floor glides
- Designed for commercial environments.
- Proudly made in America
- Dimensions:
  - Width: 19"
  - Depth: 24"
  - Height: 43.5"
  - Seat Height: 30"



## Model: JMS-612DC

- Modern x-back metal design
- Offered with padded vinyl 2.5" thick seats covered with premium commercial grade vinyl with abrasion resistance of 500,000 double rubs.
- The chair can hold up to 350 lb. of weight
- Powder coated frame finish
- 18 gauge steel frame with welded joint assembly
- Plastic floor glides
- Designed for commercial environments.
- Proudly made in America
- Dimensions:
  - Width: 17"
  - Depth: 18"
  - Height: 34.5"
  - Seating Size: 17"W x 16"D
  - Seat Height: 18"
  - Weight: 13 lbs



## Model: JMS-612BS

- Modern x-back metal design
- Offered with padded vinyl 2.5" thick seats covered with premium commercial grade vinyl
- Upholstery:
  - A beautifully leather-textured performance vinyl with abrasion resistance of 500,000 doubles rubs.
  - Phthalate free and Lead free. It is California TB 117 fire code certified.
  - Common applications id in hospitality, healthcare, contract, education, marine and automotive industries.
- The bar stool can hold up to 350 lb. of weight.
- Powder coated frame finish
- 18 gauge steel frame with welded joint assembly and support bar
- Plastic floor glides
- Designed for commercial environments.
- Proudly made in America
- Dimensions:
  - Width: 17"
  - Depth: 18"
  - Height: 41.5"
  - Seating Size: 17"W x 16"D
  - Seat Height: 30"
  - Weight: 14.5 lbs





## Model: JMS-690DC

- Modern fully padded-back metal design
- Offered with padded vinyl 2.5" thick seats.
- Upholstery:
  - A beautifully leather-textured performance vinyl with abrasion resistance of 500,000 double rubs.
  - Phthalate free and Lead free. It is California TB 117 fire code certified.
  - Common applications include in hospitality, healthcare, contract, education, marine and automotive industries.
- The chair can hold up to 350 lb. of weight.
- Powder coated frame finish 18 gauge steel frame with welded joint assembly
- Plastic floor glides
- Designed for commercial environments.
- Proudly made in America Matching bar stool is available
- Dimensions:
  - Width: 18"
  - Depth: 18"
  - Height: 31"
  - Seating Size: 18"W x 15"D
  - Seat Height: 19"
  - Weight: 17 lbs



## Model: JMS-690BS

- Modern fully padded-back metal design
- Upholstery:
  - A beautifully leather-textured performance vinyl with abrasion resistance of 500,000 double rubs.
  - Phthalate free and Lead free. It is California TB 117 fire code certified.
  - Common applications are in hospitality, healthcare, contract, education, marine and automotive industries.
- Powder coated frame finish
- 18 gauge steel frame with welded joint assembly with support bar. 450lbs Rated
- Plastic floor glides
- Designed for commercial environments.
- Proudly made in America
- Dimensions:
  - Width: 18"
  - Depth: 18"
  - Height: 41"
  - Seating Size: 18"W x 15"D
  - Seat Height: 31"
  - Weight: 21 lbs



## Model: JMS-441DC

- Padded Performance Caavelle vinyl upholstered back and seat.
- We use highest quality commercial grade vinyl in all of our products, which feature CA117 fire retardant foam with 500,000 double rubs abrasion resistance.
- Any of our furniture can be upholstered in identical material of your choice, which will result in a seamless personal collection that will best suit your decor plans.
- Gunmetal powder coated metal frame with welded joint assembly
- Plastic floor glides
- Designed for commercial environments.
- Proudly made in America
- Dimensions:
  - Width: 21"
  - Depth: 24"
  - Height: 34"
  - Seat Height: 18"



## Model: JMS-551BS

- A beautifully leather-textured performance vinyl with abrasion resistance of 500,000 double rubs.
- Phthalate free and Lead free. It is California TB 117 fire code certified.
- Common applications include in hospitality, healthcare, contract, education, marine and automotive industries.
- Any of our furniture can be upholstered in identical material of your choice, which will result in a seamless personal collection that will best suit your decor plans, such as same material choices on booth, sofas, chairs, etc.
- Gunmetal powder coated metal frame with welded joint assembly.
- Frame has a UV protection coating, which suits it for outdoor use when combined with outdoor-ready upholstery material or teak. Please note Classic vinyl collection is for indoor use only.
- Plastic floor glides
- Designed for commercial environments.
- Proudly made in America
- Dimensions:
  - Width: 21"
  - Depth: 21"
  - Height: 41"
  - Seat Height: 30"



## Model: JMS-222BS

- Gunmetal powder coated frame finish
- 18 gauge steel frame with welded joint assembly
- Comfort Padded Carvelle vinyl upholstered seat:
  - Upholstery is Quick Ship Performance: A supple leather grain high-performance commercial grade-vinyl features an abrasion resistance of 500,000 double rubs.
  - Phthalate free and Lead free. It is California TB 117 fire code certified.
  - Common applications is in hospitality, healthcare, contract, education, marine and automotive industries.
- This bar stool is a perfect addition to any environment to provide commercial-grade durability, function and space efficiency.
- Plastic floor glides
- Designed for commercial environments
- Proudly made in America
- Dimensions:
  - Round: 18"
  - Height: 30"





## Model: JMS-333BS

- Gunmetal powder coated frame finish
- 18 gauge steel heavy duty frame with welded joint assembly
- Upholstered using premium quality Quick Ship performance commercial grade vinyl with a 500,000 double rubs resistance.
- Padded vinyl upholstered seat. CA117.
- Plastic floor glides
- Designed for commercial environments
- Support up to 350lbs
- Custom colors and materials are available. Please contact us.
- Proudly made in America
- Dimensions:
  - Width: 16"
  - Depth: 16"
  - Height: 31"





## Model: JMS-CN714

- Padded vinyl upholstered back and seat. CA117 fire retardant foam.
- Upholstery:
  - A beautifully leather-textured performance vinyl with abrasion resistance of 500,000 double rubs.
  - Phthalate free and Lead free. It is California TB 117 fire code certified.
  - Common applications are in hospitality, healthcare, contract, education, marine and automotive industries.
- Gunmetal powder coated iframe with welded joint assembly
- Plastic floor glides
- Designed for commercial environments.
- Proudly made in America
- Dimensions:
  - Width: 18"
  - Depth: 24"
  - Height: 40"
  - Seat Height: 18"

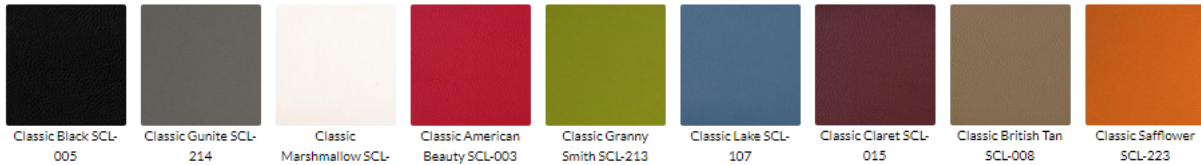

## Model: JMS-BS4017

- The contemporary aesthetics of this gorgeous bar stool marries elegant modern metal legs and wood frame with high performance exquisite blends of upholstery options.
- The base allows for an effortless 360 degree swivel movement- make it easier for your patrons to sit down by the bar.
- Legs are metal in black finish.
- All joints are glued, screwed, and connected by mortise and big tenon.
- Comfortable seat cushion is made from high-quality CAL 117 high density foam.
- Upholstery options:
  - Symphony Collection Classic: The supple hand and texture of pebble grain leather with Resilience-SR protection. Super high-performance commercial grade-vinyl featuring 500,000 double rubs, California and Boston fire codes certifications. Common applications in hospitality, healthcare, contract, education, marine and automotive industries.
  - Glossy Glaze Collection: Features beautiful, smooth and semi-glossy leather grain pattern. Excellent performance commercial grade-vinyl with 100,000 double rubs. Phthalate free and Lead free. It is California TB 117 fire code certified. Common applications id in hospitality, healthcare, contract, education, marine and automotive industries.
  - Soft-Feel Como Fabric Upholstery: Features beautiful and soft fabric pattern. Excellent performance commercial grade-fabric with 100,000 double rubs. Phthalate free and Lead free. It is California TB 117 fire code certified. Common applications id in hospitality, healthcare, contract, education, marine and automotive industries.
- Dimensions:
  - Width: 22.5"
  - Depth: 22"
  - Height: 44"
  - Seating Height: 31"
  - Seating Depth: 21.5"







**Model: JMS-CN716C-WS**

- Modern vertical-back metal design
- Wood seat in walnut finish
- Powder coated frame finish
- 18 gauge steel frame with welded joint assembly
- Plastic floor glides
- Designed for commercial environments.
- Proudly made in America
- Dimensions:
  - Width: 17"
  - Depth: 16"
  - Height: 36.5"
  - Seating Size: 17"W x 16"D
  - Seat Height: 18"
  - Weight: 16 lbs



## Model: JMS-CN761BS-WS

- Modern vertical-back metal design
- Wood seat in a walnut finish
- Powder coated frame finish
- 18 gauge steel frame with welded joint assembly
- Plastic floor glides
- Designed for commercial environments.
- Proudly made in America
- Dimensions:
  - Width: 17"
  - Depth: 16"
  - Height: 41"
  - Seating Size: 17"W x 16"D
  - Seat Height: 30"
  - Weight: 15.5 lbs

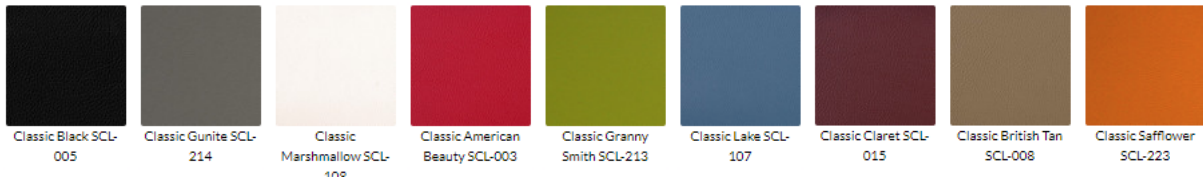

## Model: JMS-DC761

- Modern vertical-back metal design
- Offered with padded vinyl 2.5" thick seats covered with premium commercial grade vinyl with abrasion resistance of 500,000 double rubs.
- The chair can hold up to 350 lb. of weight.
- Powder coated frame finish
- 18 gauge steel frame with welded joint assembly
- Plastic floor glides
- Designed for commercial environments.
- Proudly made in America
- Dimensions:
  - Width: 17"
  - Depth: 16"
  - Height: 36.5"
  - Seating Size: 17"W x 16"D
  - Seat Height: 18"
  - Weight: 16 lbs





## Model: JMS-BS761

- Modern vertical-back metal design
- Wood seat in a walnut finish
- Powder coated frame finish
- 18 gauge steel frame with welded joint assembly
- Plastic floor glides
- Designed for commercial environments.
- Proudly made in America
- Dimensions:
  - Width: 17"
  - Depth: 16"
  - Height: 41"
  - Seating Size: 17"W x 16"D
  - Seat Height: 30"
  - Weight: 15.5 lbs



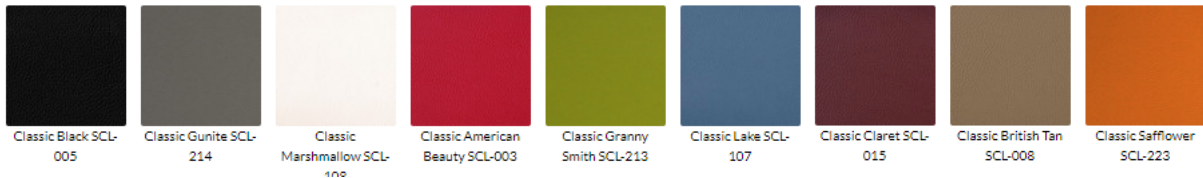

## Model: JMS-CN771LB

- Upholstery:
  - A beautifully leather-textured performance vinyl with abrasion resistance of 500,000 double rubs.
  - Phthalate free and Lead free. It is California TB 117 fire code certified.
  - Common applications are in hospitality, healthcare, contract, education, marine and automotive industries.
- Powder coated frame finish
- 18 gauge steel frame with welded joint assembly
- Plastic floor glides
- Designed for commercial environments.
- Proudly made in America
- Dimensions:
  - Width: 18"
  - Depth: 21"
  - Height: 36.5"
  - Seat Height: 18.5"

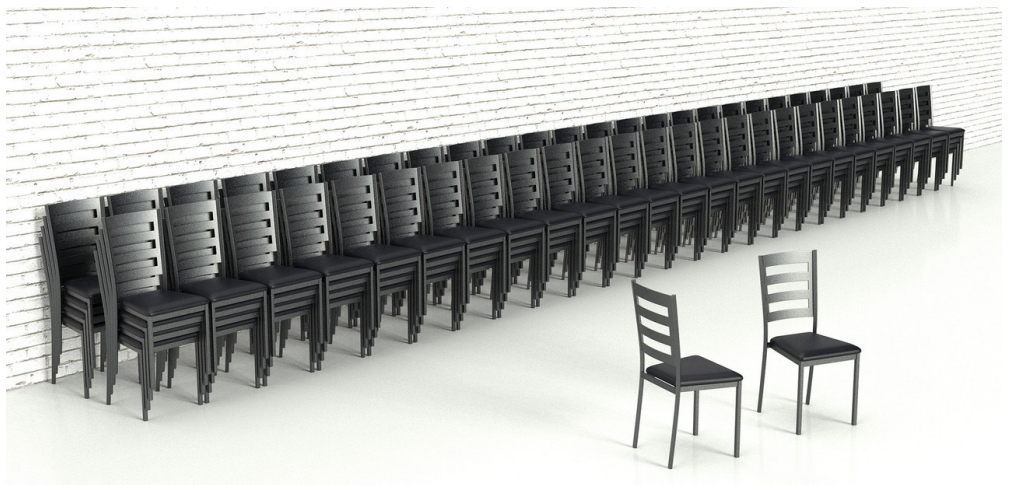



## Model: JMS-CN771BS

- Modern vertical-back metal design
- Upholstery:
  - A beautifully leather-textured performance vinyl with abrasion resistance of 500,000 double rubs.
  - Phthalate free and Lead free. It is California TB 117 fire code certified.
  - Common applications are in hospitality, healthcare, contract, education, marine and automotive industries.
- Powder coated frame finish
- 18 gauge steel frame with welded joint assembly
- Plastic floor glides
- Designed for commercial environments.
- Proudly made in America
- Dimensions:
  - Width: 17"
  - Depth: 16"
  - Height: 41"
  - Seating Size: 17"W x 16"D
  - Seat Height: 30"
  - Weight: 15.5 lbs





Dimensions:

- Width: 22.5"
- Depth: 23"
- Height: 30"
- Seating Height: 18.5"
- Seat 18" x 19"



**Model: JMS-1832**

- The contemporary aesthetics of this gorgeous chair marries elegant modern metal legs and wood frame with high performance exquisite blends of upholstery options.
- Chair is made from premium-grade rubberwood - an environmentally friendly tropical hardwood.
- Legs are metal and are available in black and gold finishes.
- All joints are glued, screwed, and connected by mortise and big tenon.
- Comfortable seat cushion is made from high-quality CAL 117 high density foam.
- Upholstery options:
  - Symphony Collection Classic: The supple hand and texture of pebble grain leather with Resilience-SR protection. Super high-performance commercial grade-vinyl featuring 500,000 double rubs, California and Boston fire codes certifications. Common applications in hospitality, healthcare, contract, education, marine and automotive industries.
  - Glossy Glaze Collection: Features beautiful, smooth and semi-glossy leather grain pattern. Excellent performance commercial grade-vinyl with 100,000 double rubs. Phthalate free and Lead free. It is California TB 117 fire code certified. Common applications in hospitality, healthcare, contract, education, marine and automotive industries.
  - Soft-Feel Como Fabric Upholstery: Features beautiful and soft fabric pattern. Excellent performance commercial grade-fabric with 100,000 double rubs. Phthalate free and Lead free. It is California TB 117 fire code certified. Common applications in hospitality, healthcare, contract, education, marine and automotive industries.



**Model: JMS-BS3001**

- The contemporary aesthetics of this gorgeous bar stool marries elegant modern metal legs and wood frame with high performance exquisite blends of upholstery options.
- The base allows for an effortless 360 degree swivel movement- make it easier for your patrons to sit down by the bar.
- Legs and base have a gunmetal finish.
- All joints are glued, screwed, and connected by mortise and big tenon.
- Comfortable seat cushion is made from high-quality CAL 117 high density foam.
- Upholstery options:
  - Symphony Collection Classic: The supple hand and texture of pebble grain leather with Resilience-SR, protection. Super high-performance commercial grade-vinyl featuring 500,000 double rubs, California and Boston fire codes certifications. Common applications in hospitality, healthcare, contract, education, marine and automotive industries.
  - Glossy Glaze Collection: Features beautiful, smooth and semi-glossy leather grain pattern. Excellent performance commercial grade-vinyl with 100,000 double rubs. Phthalate free and Lead free. It is California TB 117 fire code certified. Common applications id in hospitality, healthcare, contract, education, marine and automotive industries.
- Dimensions:
  - Width: 22.5"
  - Depth: 22"
  - Height: 44"
  - Seating Height: 31"
  - Seating Depth: 21.5"
  - Seating Areal 18" x 21.5"





**Model: JMS-BS3006**

- The contemporary aesthetics of this gorgeous bar stool marries elegant modern metal legs and wood frame with high performance exquisite blends of upholstery options.
- The base allows for an effortless 360 degree swivel movement- make it easier for your patrons to sit down by the bar.
- Legs and base have a gunmetal finish.
- All joints are glued, screwed, and connected by mortise and big tenon.
- Comfortable seat cushion is made from high-quality CAL 117 high density foam.
- Upholstery options:
  - Symphony Collection Classic: The supple hand and texture of pebble grain leather with Resilience-SR protection. Super high-performance commercial grade-vinyl featuring 500,000 double rubs, California and Boston fire codes certifications. Common applications in hospitality, healthcare, contract, education, marine and automotive industries.
  - Glossy Glaze Collection: Features beautiful, smooth and semi-glossy leather grain pattern. Excellent performance commercial grade-vinyl with 100,000 double rubs. Phthalate free and Lead free. It is California TB 117 fire code certified. Common applications id in hospitality, healthcare, contract, education, marine and automotive industries.
- Dimensions:
  - Width: 23"
  - Depth: 22"
  - Height: 37"
  - Seating Height: 30.5"
  - Seating Depth: 19"



**Model: JMS-BS3003**

- The contemporary aesthetics of this gorgeous bar stool marries elegant modern metal legs and wood frame with high performance exquisite blends of upholstery options.
- The base allows for an effortless 360 degree swivel movement- make it easier for your patrons to sit down by the bar.
- Legs and base have a gunmetal finish.
- All joints are glued, screwed, and connected by mortise and big tenon.
- Comfortable seat cushion is made from high-quality CAL 117 high density foam.
- Upholstery options:
  - Symphony Collection Classic: The supple hand and texture of pebble grain leather with Resilience-SR protection. Super high-performance commercial grade-vinyl featuring 500,000 double rubs, California and Boston fire codes certifications. Common applications in hospitality, healthcare, contract, education, marine and automotive industries.
  - Glossy Glaze Collection: Features beautiful, smooth and semi-glossy leather grain pattern. Excellent performance commercial grade-vinyl with 100,000 double rubs. Phthalate free and Lead free. It is California TB 117 fire code certified. Common applications id in hospitality, healthcare, contract, education, marine and automotive industries.
- Dimensions:
  - Width: 23"
  - Depth: 22"
  - Height: 40"
  - Seating Height: 30.5"
  - Seating Depth: 19"



Length:

27"

48"

60"

73"

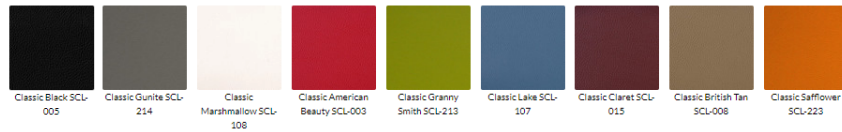

## Model: JMS-LUGANO-X-OT

- Lugano is a modern modular collection, which is well tailored for superb comfort. Lugano collection provides perfect contemporary seating solutions for public spaces in your high traffic environment.
  - Classic Super Performance:
    - A supple leather grain with Resilience-TM protection.
    - Super high-performance commercial grade-vinyl features an abrasion resistance of 500,000 double rubs, which is approximately 5-10 times more than any chair on the market.
    - The Classic Super Performance vinyl is also Phthalate free and Lead free. It is California TB 117 fire code certified.
    - Common applications id in hospitality, healthcare, contract, education, marine and automotive industries.
  - Carbon steel frame is fully welded with a gunmetal powder coated finish.
  - Dimensions:
    - Length: 27', 48", 60' or 73"
    - Depth: 27"
    - Height 18"



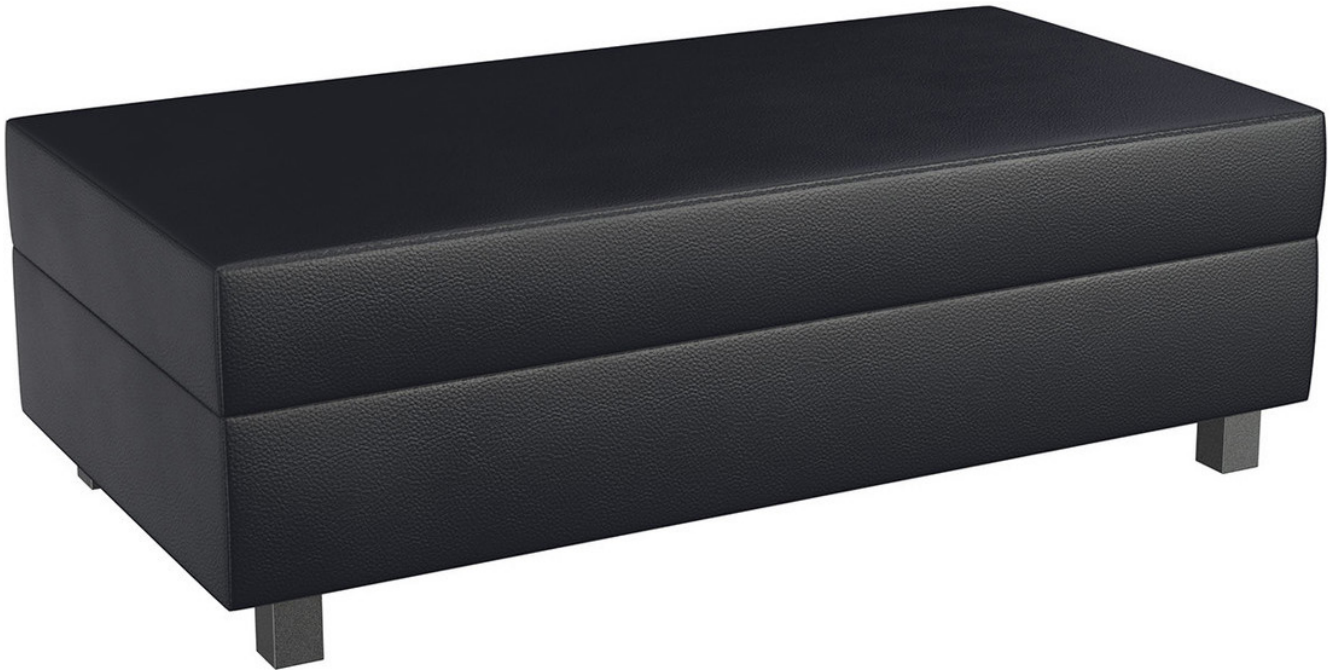

## Model: JMS-LUGANO-Z-OT

- Lugano is a modern modular collection, which is well tailored for superb comfort. Lugano collection provides perfect contemporary seating solutions for public spaces in your high traffic environment.
  - Classic Super Performance:
    - A supple leather grain with Resilience™ protection.
    - Super high-performance commercial grade-vinyl features an abrasion resistance of 500,000 double rubs, which is approximately 5-10 times more than any chair on the market.
    - The Classic Super Performance vinyl is also Phthalate free and Lead free. It is California TB 117 fire code certified.
    - Common applications id in hospitality, healthcare, contract, education, marine and automotive industries.
  - Dimensions:
    - Width: 48"
    - Depth: 27"
    - Height: 17.5"

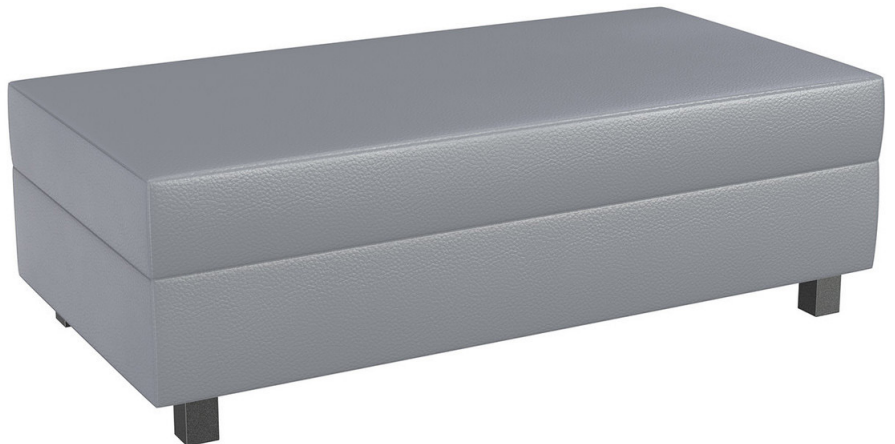

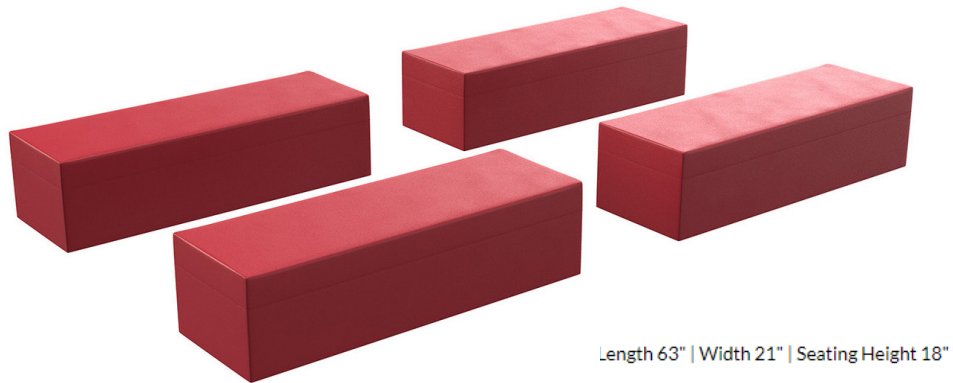
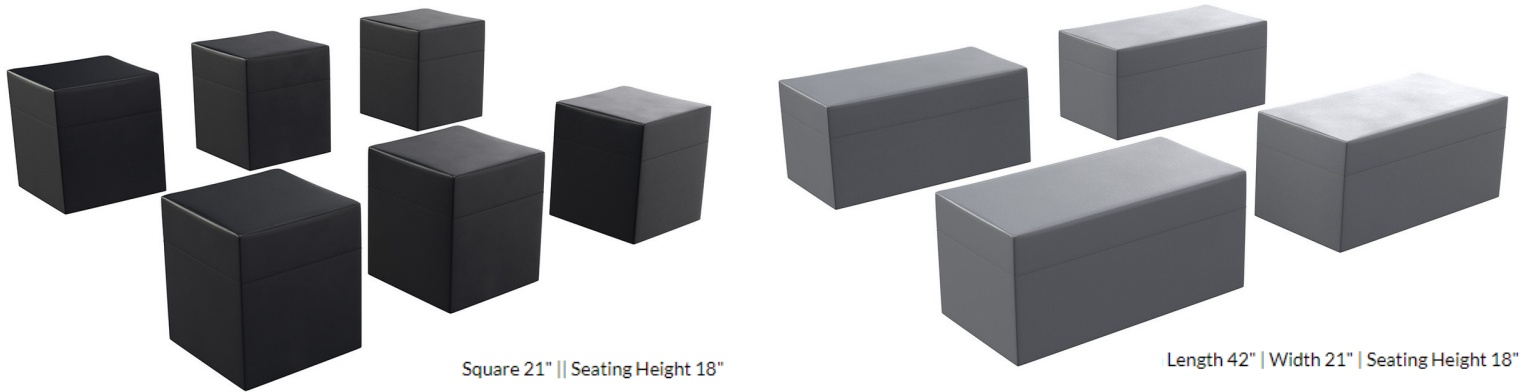

## Model: JMS-9049Z-BENCHES



- Upholstery:
  - Commercial-grade vinyl with an abrasion resistance of 500,000 double rubs.
  - Phthalate free and Lead free. It is California TB 117 fire code certified.
  - Common applications in hospitality, healthcare, contract, education, marine and automotive industries.
- The clean lines design will give your establishment or event an exclusive and an impressive modern appeal.
- The 21" depth seating surface allows for ample seating space and comfort. This product was designed to occupy the least amount of space while providing the maximum amount of seating.
- Built to be both lightweight and sturdy, pieces can be transported with ease and used in high traffic areas.
- Frame is built of solid hardwood. Cushion is made of high density CAL 117 certified foam. Joints are glued, stapled and screwed to ensure frame stability and longevity.
- Base sits on metal base glides



## Model: JMS-STOOLS

- Featured Upholstery is
  - High-performance commercial grade-vinyl features an abrasion resistance of 500,000 double rubs.
  - Phthalate free and Lead free. It is California TB 117 fire code certified.
  - Upholstered banquette seating with deep soft cushioned padding for the most comfort and support
  - Common applications: hospitality, healthcare, contract, education, marine and automotive industries.
- Space efficient design which allows you to capitalize on your available space while providing the most seating capacity.
- Built to be sturdy, pieces can be transported with ease and used in high traffic areas
- Upholstered with soft cushioned padding for the most comfort and support
- Frame is made from solid wood. Cushions are made of high density CAL 117 certified foam. Joints are glued, stapled and screwed to ensure frame stability and longevity.

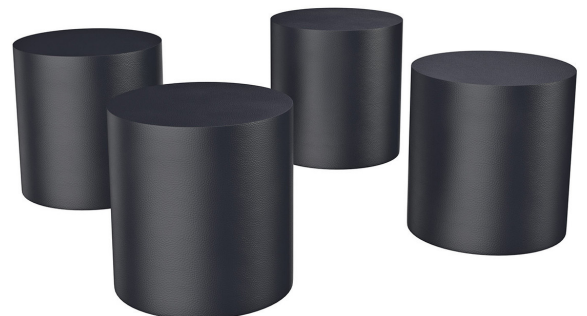



## Model: JMS-8005-OTTOMANS

- **Classic Super Performance Upholstery:**

- The fabrics are handcrafted to withstand the rigorous demands of commercial interiors within restaurants, nightclubs, education, hospitality, corporate, and healthcare environments.
- How it feels: Soft and supple hand with a true leather-pattern and texture. Performance specifications: Abrasion resistance contract-grade 500,000 double rubs. Enhanced stain resistance with a liquid barrier.
- Environmentally friendly: Phthalate Free, BPA Free, Formaldehyde Free and Lead Free. Fully compliant with all major flammability requirements such California TB 117, NFPA 260 and FMVSS 302.
- *Upholstery Care & Cleaning:* Prompt cleaning is always recommended. Clean the soiled area with mild soap and water, then rinse with fresh water and wipe down with a clean cloth.

- Only solid hardwood products are used in the frame construction. All corners are "blocked", nailed, and glued for strength and durability.

- Legs are heavy-duty metal with adjustable glides.

- **Dimensions:**

- Ottoman: Diameter 38" | Height 17"





## Model: JMS-RAYON

- Upholstery:
  - Commercial-grade vinyl with an abrasion resistance of 500,000 double rubs.
  - Phthalate free and Lead free. It is California TB 117 fire code certified.
  - Common applications in hospitality, healthcare, contract, education, marine and automotive industries.
- Built to be both lightweight and sturdy, pieces can be transported with ease and used in high traffic areas.
- Frame is built of solid hardwood. Cushion is made of high density CAL 117 certified foam. Joints are glued, stapled and screwed to ensure frame stability and longevity.
- Base sits on metal base glides,
- Dimensions:
  - Each Tail Component: Length: 43.50" | Seating Width: 20" | Seating Height 18"
  - Please see dimension images for overall sizes.
- Create many seating configurations from: half-a-circle, to round, s-shape and much more.

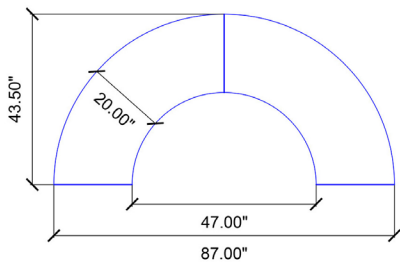

Contains: 2 Tails

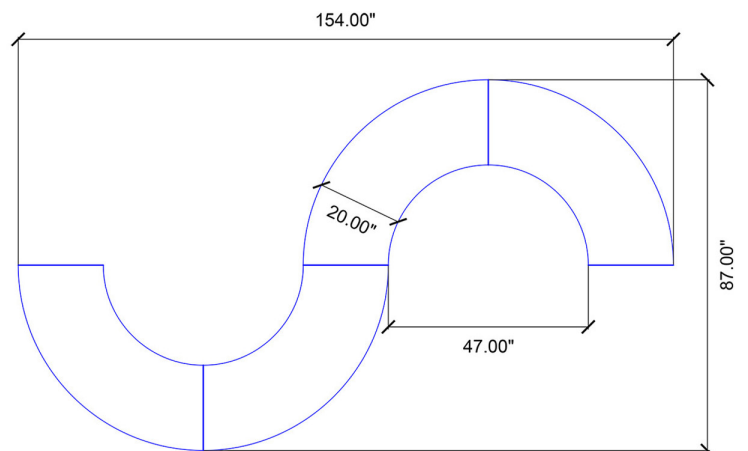

Contains: 4 Tails





Ottoman: Length 29" | Width 29" | Height 17.5"



## Model: JMS-COCO-OTTOMANS

- Contrast of curved features and clean lines will give your establishment or event an exclusive modern design with commercial grade quality.
- **Classic Super Performance Upholstery:**
  - The fabrics are handcrafted to withstand the rigorous demands of commercial interiors within restaurants, nightclubs, education, hospitality, corporate, and healthcare environments.
  - How it feels: Soft and supple hand with a true leather-pattern and texture. Performance specifications: Abrasion resistance contract-grade 500,000 double rubs. Enhanced stain resistance with a liquid barrier.
  - Environmentally friendly: Phthalate Free, BPA Free, Formaldehyde Free and Lead Free. Fully compliant with all major flammability requirements such California TB 117, NFPA 260 and FMVSS 302.
  - *Upholstery Care & Cleaning:* Prompt cleaning is always recommended. Clean the soiled area with mild soap and water, then rinse with fresh water and wipe down with a clean cloth.
- Built to be both lightweight and sturdy, pieces can be transported with ease and used in high traffic areas.
- Frame is built of solid hardwood. Cushion is made of high density CAL 117 certified foam. Joints are glued, stapled and screwed to ensure frame stability and longevity.
- Base sits on metal base glides
- When combined with other modular components, pieces can be re-arranged to suit different applications and offer various layout options
- Dimensions:
  - Ottoman: Length 29" | Width 29" | Height 17.5"



**Model: JMS Hermosa Lounge Seating**

- Heavy-duty Made-in-USA premium quality product - designed for safe operation in commercial environment such as restaurants, night-clubs, lounges and casinos.
- Carbon steel heavy-duty powder-coated gunmetal frame
- Premium Sunbrella® Fabric Cushions and Pillows (5-year Limited Warranty) - This limited warranty protects the original purchaser from Sunbrella marine fabric becoming unserviceable due to color or strength loss from normal usage and exposure conditions, including sun-light, mildew and atmospheric chemicals. The limited warranty coverage period is five years from the of original installation
- Dimensions:
- Left / Right Component Length: 47"
- Armless Extension Component Length: 42"
- Corner Component Length: 27"
- Width: 27"
- Height: 29"
- Seating Height: 15"
- Seating Depth: 24"

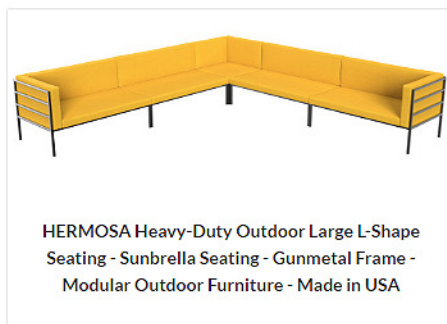
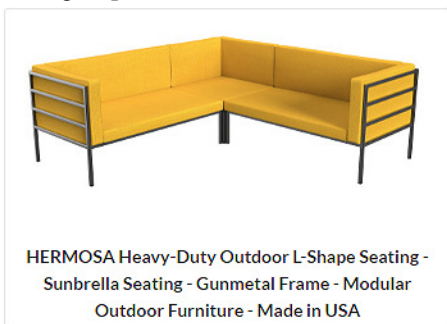



Sofa Length:

2-Seater 52"

3-Seater 73"



## Model: JMS Hermosa Sofa / Chair

- Heavy-duty Made-in-USA premium quality product - designed for safe operation in commercial environment such as restaurants, night-clubs, lounges and casinos.
- Carbon steel heavy-duty powder-coated gunmetal frame
- Premium Sunbrella® Fabric Cushions and Pillows (5-year Limited Warranty) - This limited warranty protects the original purchaser from Sunbrella marine fabric becoming unserviceable due to color or strength loss from normal usage and exposure conditions, including sunlight, mildew and atmospheric chemicals. The limited warranty coverage period is five years from the of original installation
- Dimensions:
- Sofa Length: 52" or 73"
- Chair Length: 36"
- Width: 27"
- Height: 29"
- Seating Height: 15"
- Seating Depth: 24"
- Sofa Seating Widths: 46" (52" Length), 65.5" (73"Length)"
- Chair Seating Width: 19.5"

### SUNBRELLA WATERPROOF TECHNOLOGY

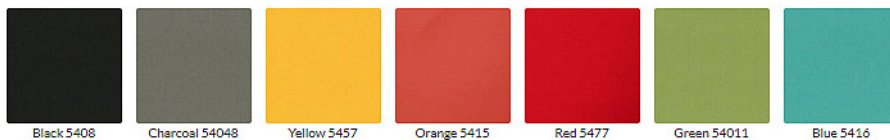

Black 5408

Charcoal 54048

Yellow 5457

Orange 5415

Red 5477

Green 54011

Blue 5416



Sunbrella® Color:

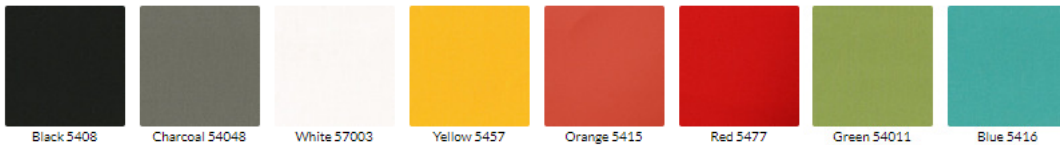

Frame Seaboard® Finishes:



## Model: JMS Carina Modular Outdoor Seating

- Heavy-duty Made-in-USA premium quality outdoor product - designed for safe operation in commercial outdoor environment such as restaurants, nightclubs, lounges and casinos.
- Premium Sunbrella® Fabric Cushions and Pillows (5-year Limited Warranty) - This limited warranty protects the original purchaser from Sunbrella marine fabric becoming unserviceable due to color or strength loss from normal usage and exposure conditions, including sunlight, mildew and atmospheric chemicals. The limited warranty coverage period is five years from the of original installation
- Outdoor Seaboard frames are made from commercial marine-grade high-density polyethylene material.
- Suitable for all high traffic indoor and outdoor environments, especially in the restaurants and hospital industry.
- Has a beautiful top teak texture which reduces slip and provides durability against scratches.
- A unique and advanced, high-density polyethylene building sheet that lasts a lifetime.
- A matte gloss finish on both sides It is environmentally stabilized to withstand the harshest outdoor conditions.
- Will not rust, delaminate or rot when exposed to UV, humidity or water. It never needs painting or refinishing





### Model: JMS Outdoor Communal Table

- This table top is made from commercial marine-grade high-density StarBoard material.
- StarBoard is suitable for all high traffic indoor and outdoor environments, especially in the restaurants and hospital industry.
- This table has a beautiful top teak texture which reduces slip and provides durability against scratches.
- StarBoard is a unique and advanced, high-density polyethylene building sheet that lasts a lifetime.
- StarBoard has a matte gloss finish on both sides. It is environmentally stabilized to withstand the harshest outdoor conditions.
- StarBoard will not rust, delaminate or rot when exposed to UV, humidity or water. It never needs painting or refinishing
- Table Dimensions:
  - Table top thickness is 3/4 inch
  - Table Top is 36" x 84"
  - Height: 42"
- Custom bevel edges and table top sizes are available. Please contact us.
- Frame is UV powder coated (black or silver) carbon steel fully welded frame.
- Built for high traffic areas.
- Handcrafted in New Jersey.
- This product is fully assembled.





Color / Finish:

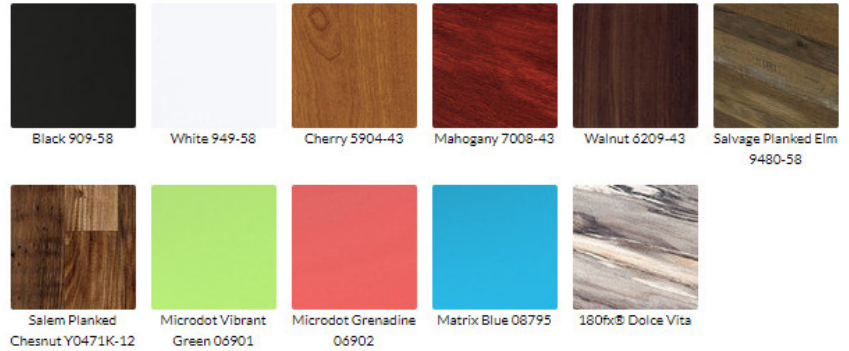

## Model: JMS-Wall Dining Table

- This custom product was designed to provide baseless aesthetically appealing restaurant tables that can accommodate two or more patrons in your establishment. This very space-efficient design provides the warmth and coziness of a luxurious dining experience where the restaurant wall table is suspended in air, it's an art form in itself. The framework underneath the wood is a solid metal L-shape constructed frame that easily anchors to the wall.
- We use the world's renowned very high quality laminate from brands such as Formica® and Wilsonart®.
- We believe in using the best laminate in order to ensure the product is very durable and is ready for your place of business. Do not settle for cheap generic laminate from our competitors.
- Laminate features fire resistance Grade 32 / 50. Stain, scratch and impact resistant under normal use conditions.
- Wall table thickness with laminate is 1-1/6". We can customize to any thickness and size.
- We create each table top from scratch to meet your exact criteria. Hand made in USA.
- Our wall-mounted tables are made from 1-1/8" high quality industrial grade plywood.
- Our frames are made of 1" tubular steel.
- We use only high quality commercial-grade materials to ensure longevity and durability in high traffic areas.
- Table Top 24" x 24" x 1.5"





**Table 2-3" Top - Round, Square or Rectangle - Many Sizes Available - Handcrafted in USA**

Laminate Color:



Salvage Planked Elm  
9480-58



180fx Calacatta  
Marble 3460

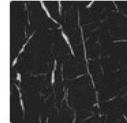

180fx Nero  
Marquina 7403



180fx Dolce Vita  
3420



Wilsonart Antique  
Bourbon Pine 8215



Wilsonart Antique  
Marula Pine 8216



Wilsonart  
Repurposed Oak  
Y0365



Wilsonart  
Repurposed Oak  
Planked Y0364

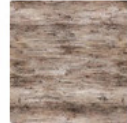

Wilsonart Beach  
Antique Wood  
Y0269



Table Top Size:

<input checked="" type="checkbox"/> Square 24"	<input type="checkbox"/> Square 30"	<input type="checkbox"/> Square 36"	<input type="checkbox"/> Square 42"	<input type="checkbox"/> Square 48"	<input type="checkbox"/> Square 60"
<input type="checkbox"/> Round 18"	<input type="checkbox"/> Round 24"	<input type="checkbox"/> Round 30"	<input type="checkbox"/> Round 36"	<input type="checkbox"/> Round 42"	<input type="checkbox"/> Round 48"
<input type="checkbox"/> Round 60"	<input type="checkbox"/> 24" by 30"	<input type="checkbox"/> 24" by 36"	<input type="checkbox"/> 24" by 42"	<input type="checkbox"/> 24" by 48"	<input type="checkbox"/> 24" by 60"
<input type="checkbox"/> 24" by 72"	<input type="checkbox"/> 24" by 84"	<input type="checkbox"/> 24" by 96"	<input type="checkbox"/> 30" by 36"	<input type="checkbox"/> 30" by 42"	<input type="checkbox"/> 30" by 48"
<input type="checkbox"/> 30" by 60"	<input type="checkbox"/> 30" by 72"	<input type="checkbox"/> 30" by 84"	<input type="checkbox"/> 30" by 96"	<input type="checkbox"/> 36" by 42"	<input type="checkbox"/> 36" by 48"
<input type="checkbox"/> 36" by 60"	<input type="checkbox"/> 36" by 72"	<input type="checkbox"/> 36" by 84"	<input type="checkbox"/> 36" by 96"		

Wood Thickness:

<input checked="" type="checkbox"/> 2 Inches	<input type="checkbox"/> 3 Inches
--	-----------------------------------

**Model: JMS-Table Top 2" / 3" (Formica®)**

- We use the world's renowned very high quality laminate brand Formica®
- True-to-scale patterns that offer visual drama unmatched by any other laminate. Modern, sophisticated premium wood patterns focus on a neutral palette – versatile enough to pair with any interior design concept.
- We believe in using the best laminate in order to ensure the product is very durable and is ready for your place of business. Do not settle for cheap generic laminate from our competitors.
- Available in various dimensions, these table tops offer the flexibility to customize the shape and size according to your needs.
- Featuring a laminated finish, this table is thoroughly protected from heat, moisture and scratches.
- With exceptional design and craftsmanship, this table perfectly compliments any aesthetic.
- We create each table top from scratch to meet your exact criteria. Hand made in our NJ facility.
- Our table are made from 2-1/8" / 3-1/8" natural wood frame and high quality industrial grade plywood.
- Table top thickness with laminate top is 2-1/6" or 3-1/6". We can customize to any thickness and size.
- Laminate features fire resistance Grade 32 / 50. Stain, scratch and impact resistant under normal use conditions.
- This product will have the same edge banding as the table top itself for a uniform look.
- Please call us with any questions or customizations.
- Table Thickness Availability: 2" or 3"



Color / Finish:  
 Wilsonart Rediscovered Oak Planked Y0303K-12

**Premium Table Tops - 2" or 3" Thick - Round, Square or Rectangle - 30+ Sizes Available - Handcrafted in USA**

Laminate Finish:



White Knotty Maple  
 7410



Wilsonart Salem  
 Planked Chestnut  
 Y0471K-12



Wilsonart  
 Rediscovered Oak  
 Planked Y0303K-12

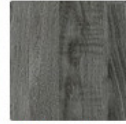

Wilsonart Pepper  
 Planked Alona  
 Y0463KK-12



Wilsonart Mocha  
 Olive Y0575K-16



Wilsonart  
 Whitewashed Brick  
 Landscape Y0681K-  
 60

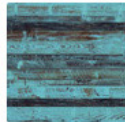

Wilsonart Border  
 Blue Pine Y0485

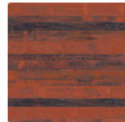

Wilsonart Rancho  
 Red Pine Y0484



Wilsonart Antique  
 Wood Y0056

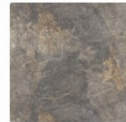

Wilsonart Istanbul  
 Marble 7405

Table Top Size:

<input checked="" type="checkbox"/> Square 24"	<input type="checkbox"/> Square 30"	<input type="checkbox"/> Square 36"	<input type="checkbox"/> Square 42"	<input type="checkbox"/> Square 48"	<input type="checkbox"/> Square 60"
<input type="checkbox"/> Round 18"	<input type="checkbox"/> Round 24"	<input type="checkbox"/> Round 30"	<input type="checkbox"/> Round 36"	<input type="checkbox"/> Round 42"	<input type="checkbox"/> Round 48"
<input type="checkbox"/> Round 60"	<input type="checkbox"/> 24" by 30"	<input type="checkbox"/> 24" by 36"	<input type="checkbox"/> 24" by 42"	<input type="checkbox"/> 24" by 48"	<input type="checkbox"/> 24" by 60"
<input type="checkbox"/> 24" by 72"	<input type="checkbox"/> 24" by 84"	<input type="checkbox"/> 24" by 96"	<input type="checkbox"/> 30" by 36"	<input type="checkbox"/> 30" by 42"	<input type="checkbox"/> 30" by 48"
<input type="checkbox"/> 30" by 60"	<input type="checkbox"/> 30" by 72"	<input type="checkbox"/> 30" by 84"	<input type="checkbox"/> 30" by 96"	<input type="checkbox"/> 36" by 42"	<input type="checkbox"/> 36" by 48"
<input type="checkbox"/> 36" by 60"	<input type="checkbox"/> 36" by 72"	<input type="checkbox"/> 36" by 84"	<input type="checkbox"/> 36" by 96"		

Wood Thickness:

<input checked="" type="checkbox"/> 2 Inches	<input type="checkbox"/> 3 Inches
--	-----------------------------------

**Model: JMS-Table Top 2" / 3" (Wilsonart®)**

- Featuring a laminated finish, this table is thoroughly protected from heat, moisture and scratches.
- With exceptional design and craftsmanship, this table perfectly compliments any aesthetic.
- We create each table top from scratch to meet your exact criteria. Hand made in our NJ facility.
- Table top thickness with laminate top is 2-1/6" or 3-1/6". We can customize to any thickness and size.
- Laminate features fire resistance Grade 32 / 50. Stain, scratch and impact resistant under normal use conditions.
- This product will have the same edge banding as the table top itself for a uniform look.
- Table Thickness Availability: 2" or 3"
- Featured Limited Edition Laminates:
- **Salem Planked Chestnut** is a time-worn planked wood with nail and worm hole characteristics. A deep rich red brown with black graining is found throughout.
- **Mocha Olive** is a large scale dark brown monochromatic wood design in a unique figured pattern.
- **North Fork Pine** is a large-scale planked knotty pine design. The wood look is a warm natural pine color with some grey character.
- **Whitewashed Brick landscape** is a large scale brick wall design with bits of red brick showing through in a cross directional layout.
- **Rediscovered Oak Planked** has weathered, planked features in pale to medium oak tones.
- **Pepper Alona** is an open grained, plain sliced oak look with strong cathedrals in a medium grey color in a 5" plank.
- **Border Blue Pine** is a rustic planked woodgrain of varying sizes. The naked woodgrain comes through the overlay of turquoise like timeworn barnwood.
- **Rancho Red** is a deep red planked woodgrain. The deep charcoals of the woodgrain show through like time worn barnwood.
- **Antique Wood** has survived the test of time. The enduring beauty of aged and distressed wood is unmistakable. Weathered to unrefined perfection, it features naturally aged characteristics such as knots, nail holes, and cracks usually found in rustic planks.
- **Istanbul Marble** features luxurious true-to-scale marble pattern. The finish is a light texture that is smooth to the touch with a low gloss visual.



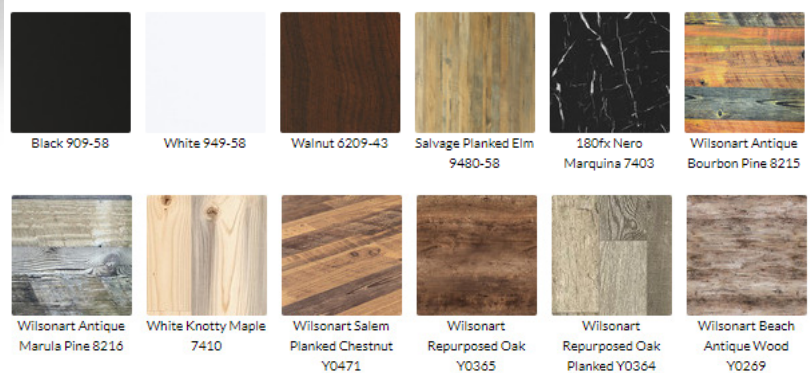

## Model: JMS-COM-30KD

- Featured long tables provide space efficiency and encourages socializing and networking when placed in high traffic areas or can be used to accommodate large parties.
- Application: offices, libraries, shop displays, front of house, lobbies, boardrooms, events and trade shows, restaurants and bars
- This popular communal bar table is available in five beautiful finishes: Black, White, Walnut, Petrified Wood and Planked Elm
- Laminate features fire resistance Grade 32 / 50. Stain, scratch and impact resistant under normal use conditions.
- Our table are made from 4" thick natural wood frame and high quality industrial grade plywood, which makes this table very sturdy, heavy and ready for high usage environments.
- We can create this communal bar table in any laminate, finish, size and custom own materials. Please contact us for details.
- Optional USB ports and 110v outlets can be installed anywhere on the table. We can customize the ports/outlets to meet any specs and demands.
- Please note the table top and two legs are individually wrapped for shipping protection. Minor assembly is required.
- Hand made in New Jersey
- Dimensions:
  - Length: 8 or 10 feet (minimum order for 10ft table is 5 units)
  - Width: 30"
  - Height: 30"
  - Weight: 8 foot table = 300 lbs, 10 foot table = 370 lbs

Optional Charging Stations  
 USB & 110v OUTLETS



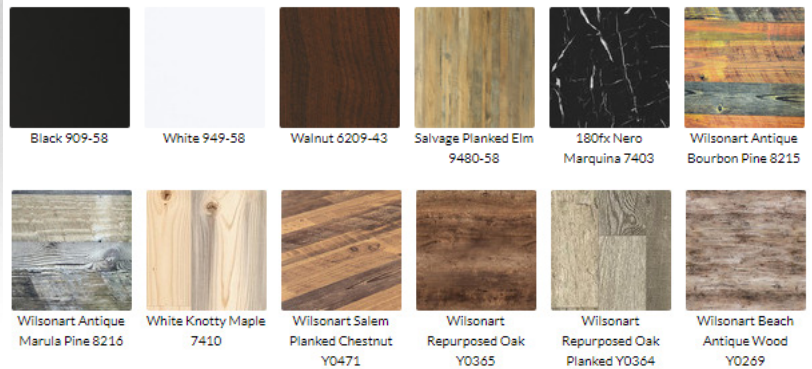

## Model: JMS-COM-42KD

- Featured long tables provide space efficiency and encourages socializing and networking when placed in high traffic areas or can be used to accommodate large parties.
- Application: offices, libraries, shop displays, front of house, lobbies, boardrooms, events and trade shows, restaurants and bars
- This popular communal bar table is available in five beautiful finishes: Black, White, Walnut, Petrified Wood and Planked Elm
- Laminate features fire resistance Grade 32 / 50. Stain, scratch and impact resistant under normal use conditions. Postform grade of 12 / 20.
- Our table are made from 4" thick natural wood frame and high quality industrial grade plywood, which makes this table very sturdy, heavy and ready for high usage environments.
- We can create this communal bar table in any laminate, finish, size and custom own materials. Please contact us for details.
- Optional USB ports and 110v outlets can be installed anywhere on the table. We can customize the ports/outlets to meet any specs and demands.
- Please note the table top and two legs are individually wrapped for shipping protection. Minor assembly is required.
- Handcrafted in New Jersey.
- Dimensions:
  - Length: 8, 9 or 10 feet (minimum order for 10ft table is 5 units)
  - Width: 30"
  - Height: 42"
  - Weight: 8 foot table = 325 lbs, 9 foot table = 350 lbs, 10 foot table = 395 lbs



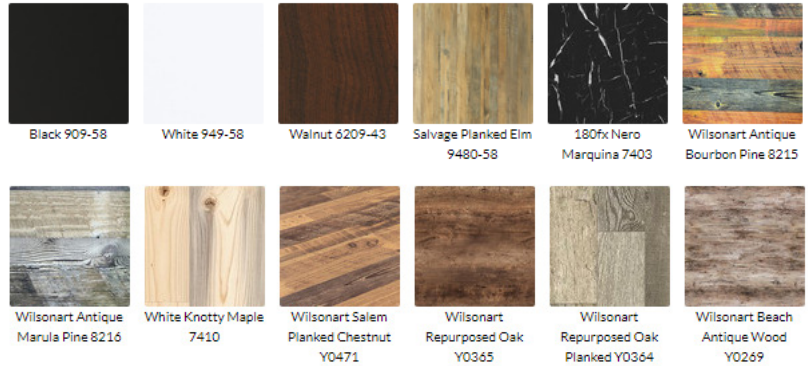

**Model: JMS-COM-42KD-10FT**

- Featured long tables provide space efficiency and encourages socializing and networking when placed in high traffic areas or can be used to accommodate large parties.
- Application: offices, libraries, shop displays, front of house, lobbies, boardrooms, events and trade shows, restaurants and bars
- This popular communal bar table is available in five beautiful finishes: Black, White, Walnut, Petrified Wood and Planked Elm
- Laminate features fire resistance Grade 32 / 50. Stain, scratch and impact resistant under normal use conditions. Postform grade of 12 / 20.
- Our table are made from 4" thick natural wood frame and high quality industrial grade plywood, which makes this table very sturdy, heavy and ready for high usage environments.
- The middle leg support is 8" wide - provides optimum stability.
- We can create this communal bar table in any laminate, finish, size and custom own materials. Please contact us for details.
- **Optional USB ports and 110v outlets can be installed anywhere on the table. We can customize the ports/outlets to meet any specs and demands. Please contact us.**
- Please note the two table tops and three legs are individually wrapped for shipping protection. Minor assembly is required.
- Handcrafted in New Jersey.
- Dimensions:
  - Length: 10 feet
  - Width: 30"
  - Height: 42"
  - Weight: 400 lbs



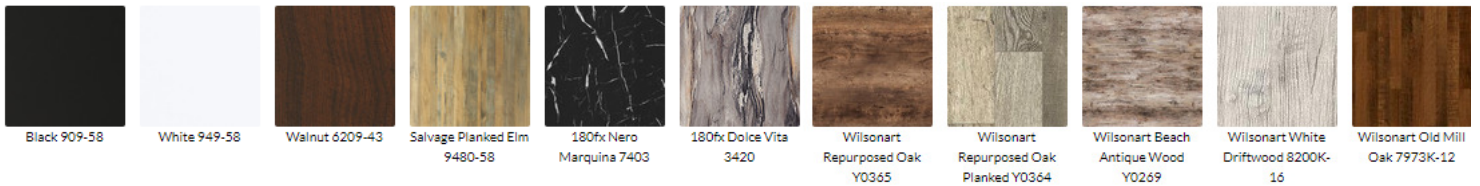

## Model: JMS-SIGMA-30

- Featured long tables provide space efficiency and encourages socializing and networking when placed in high traffic areas or can be used to accommodate large parties.
- Application: offices, libraries, shop displays, front of house, lobbies, boardrooms, events and trade shows, restaurants and bars
- Laminate features fire resistance Grade 32 / 50. Stain, scratch and impact resistant under normal use conditions.
- Our table are made from 4" thick natural wood frame and high quality industrial grade plywood, which makes this table very sturdy, heavy and ready for high usage environments.
- We can create this communal bar table in any laminate, finish, size and custom own materials. Please contact us for details.
- Optional USB ports and 110v outlets can be installed anywhere on the table. We can customize the ports/outlets to meet any specs and demands.
- This communal bar table can comfortably sit 10-12 people.
- Hand made in New Jersey
- Dimensions:
  - Length: 96"
  - Width: 36"
  - Height: 30"

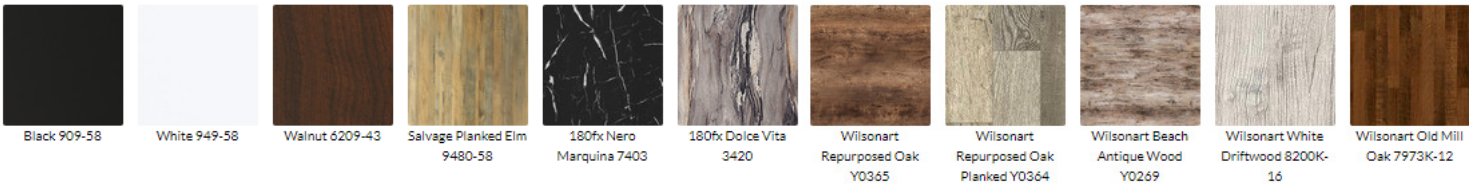

## Model: JMS-SIGMA-42

- Featured long tables provide space efficiency and encourages socializing and networking when placed in high traffic areas or can be used to accommodate large parties.
- Application: offices, libraries, shop displays, front of house, lobbies, boardrooms, events and trade shows, restaurants and bars
- Laminate features fire resistance Grade 32 / 50. Stain, scratch and impact resistant under normal use conditions.
- Our table are made from 4" thick natural wood frame and high quality industrial grade plywood, which makes this table very sturdy, heavy and ready for high usage environments.
- We can create this communal bar table in any laminate, finish, size and custom own materials. Please contact us for details.
- Optional USB ports and 110v outlets can be installed anywhere on the table. We can customize the ports/outlets to meet any specs and demands.
- This communal bar table can comfortably sit 10-12 people.
- Hand made in New Jersey
- Dimensions:
  - Length: 96"
  - Width: 36"
  - Height: 42"

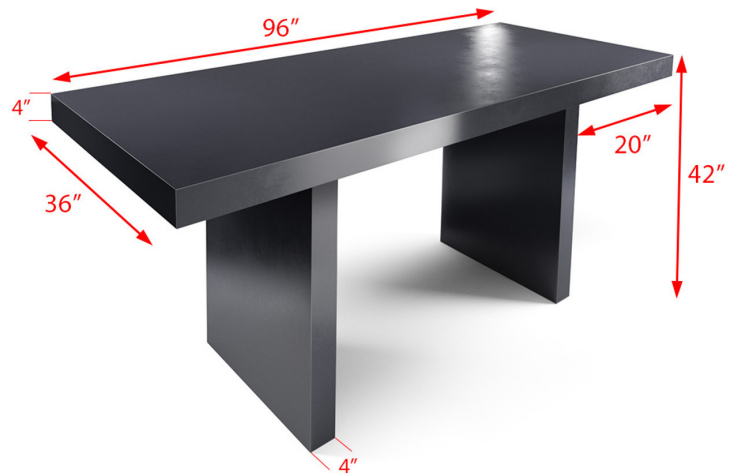



**Finish:**  
 Formica White 949-58

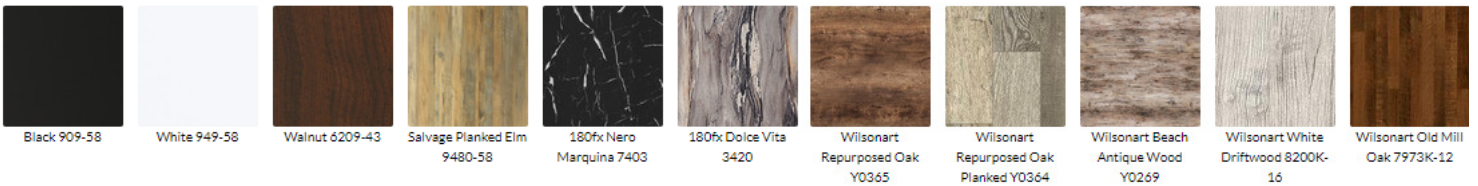

**Model: JMS-SIGMA-16FT-42**

- Featured long tables provide space efficiency and encourages socializing and networking when placed in high traffic areas or can be used to accommodate large parties.
- Application: offices, libraries, shop displays, front of house, lobbies, boardrooms, events and trade shows, restaurants and bars
- Laminate features fire resistance Grade 32 / 50. Stain, scratch and impact resistant under normal use conditions.
- Our table are made from 4" thick natural wood frame and high quality industrial grade plywood, which makes this table very sturdy, heavy and ready for high usage environments.
- We can create this communal bar table in any laminate, finish, size and custom own materials. Please contact us for details.
- **Optional USB ports and 110v outlets can e installed anywhere on the table. We can customize the ports/outlets to meet any specs and demands.**
- This communal bar table can comfortably sit 12-16 people.
- Hand made in New Jersey
- Dimensions:
  - Length: 192"
  - Width: 36"
  - Height: 42"

Optional Power Outlets



**Finish:**  
 Formica Walnut 6209-43

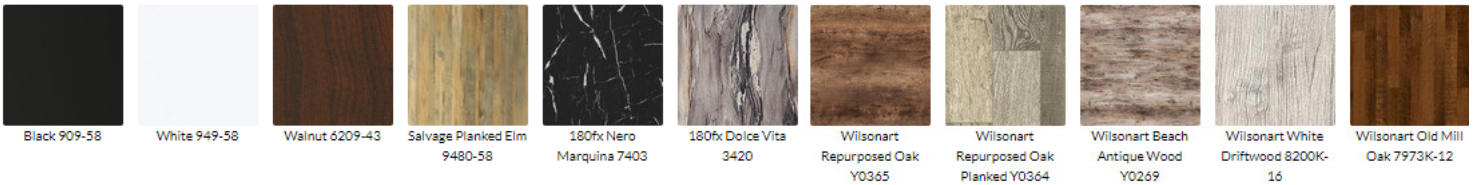

## Model: JMS-COM-4296

- Featured long tables provide space efficiency and encourages socializing and networking when placed in high traffic areas or can be used to accommodate large parties.
- Application: offices, libraries, shop displays, front of house, lobbies, boardrooms, events and trade shows, restaurants and bars
- Laminate features fire resistance Grade 32 / 50. Stain, scratch and impact resistant under normal use conditions.
- Our table are made from 4" thick natural wood frame and high quality industrial grade plywood, which makes this table very sturdy, heavy and ready for high usage environments.
- We can create this communal bar table in any laminate, finish, size and custom own materials. Please contact us for details.
- Optional USB ports and 110v outlets can be installed anywhere on the table. We can customize the ports/outlets to meet any specs and demands.
- Hand made in New Jersey
- Dimensions:
  - Length: 96"
  - Width: 30"
  - Height: 42"
  - Weight: 8 foot table approx. 250 lbs



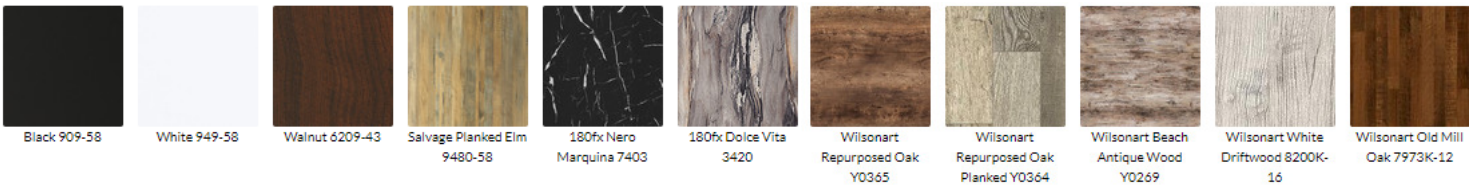

## Model: JMS-MT5

- Designed specifically for trade shows, exhibitions, conference rooms and other collaborating applications.
- Featuring three power outlets as pictured on one side only. Each outlet has [2x] USB and [2x] 110v ports. Please note, we can customize the ports/outlets to meet any specs and demands.
- Plastic grommets allow for equipment on the table to be connected to outlets underneath.
- Powder coated gunmetal carbon steel frame is fully welded - built to be used in high traffic areas.
- Table top is laminate Formica® 4 inch - Laminate features fire resistance Grade 32 / 50. Stain, scratch and impact resistant under normal use conditions.
- Can be custom made to any specifications.
- This product is fully assembled.
- Dimensions:
  - Charging Table: Length 85.5" | Width 37.5" | Bar Height of 42"





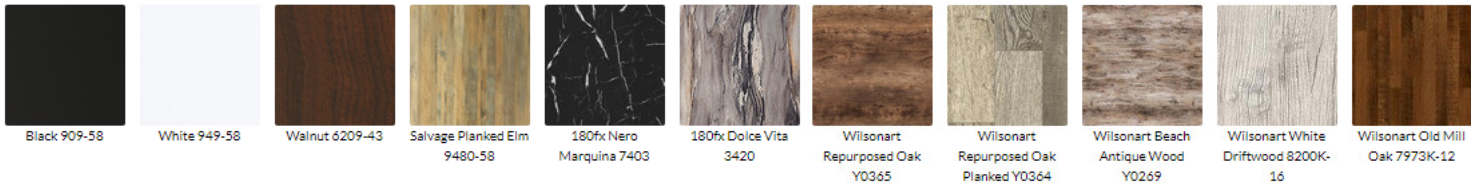

## Model: JMS-MT1-42

- Designed specifically for applications such as hospitality, contract, health care and education.
- Common applications are: campuses, libraries, great for public spaces such as lobbies, doctor's / law offices and conference rooms.
- Powder coated gunmetal carbon steel frame is fully welded - built to be used in high traffic areas.
- Table top's laminate Formica® 2.125" - Laminate features fire resistance Grade 32 / 50. Stain, scratch and impact resistant under normal use conditions.
- There are 2x USBs and 1 outlet per each corner of the privacy divider, totaling 8x USBs and 8x 110v Outlets. We can customize the ports/outlets to meet any specs and demands.
- Can be custom made to any specifications.
- Dimensions:
  - Charging Table: Length 84" | Width 36" | Height 42"

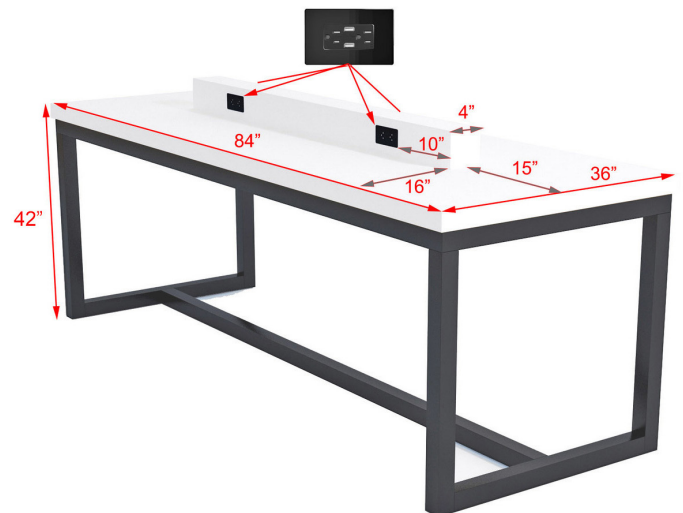

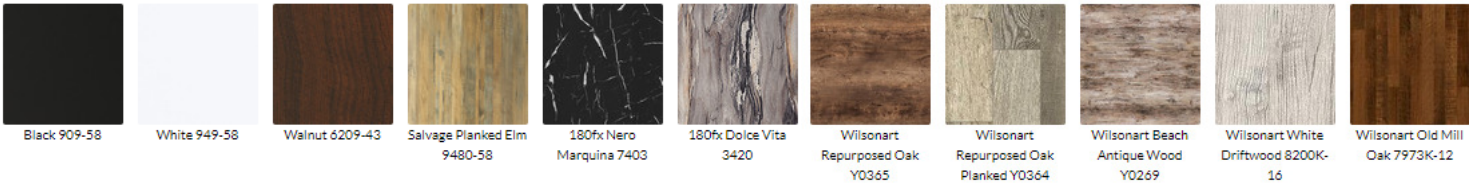

**Model: JMS-MT2-42**

- Designed specifically for applications such as hospitality, contract, health care and education.
- Common applications are: campuses, libraries, great for public spaces such as lobbies, doctor's / law offices and conference rooms.
- Powder coated gunmetal carbon steel frame is fully welded - built to be used in high traffic areas.
- Table top is laminate Formica® features fire resistance Grade 32 / 50. Stain, scratch and impact resistant under normal use conditions.
- There are 2x USB (1-USB-A & 1-USB-C) ports and 2x 110v outlets per each power dome (in total 4x USB ports and 4x 110v outlets).
- Can be custom made to any specifications.
- This product is fully assembled.
- Dimensions:
  - Charging Table: Length 84" | Width 36" | Height 42"

**Power Dome**

Plug		USB	
Receptacles	Rating	Ports	Rating
2	15A	2	2A Shared



**Color / Finish:**  
 Formica Salvage Planked Elm 9480-58

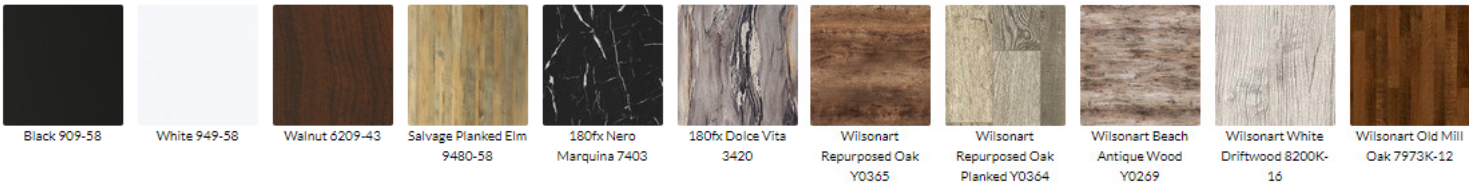

## Model: JMS-TT-2084-43MT

- Featured long bar stand-up table provide space efficiency and encourages socializing and networking when placed in high traffic areas or can be used to accommodate large parties.
- Application: offices, libraries, shop displays, front of house, lobbies, boardrooms, events and trade shows, restaurants and bars
- Laminate features fire resistance Grade 32 / 50. Stain, scratch and impact resistant under normal use conditions.
- Our table are made from 1 1/8" thick natural wood frame and high quality industrial grade plywood, which makes this table very sturdy, heavy and ready for high usage environments.
- Featuring three power outlets as pictured on one side only. Each outlet has [2x] USB and [2x] 110v ports. Please note, we can customize the ports/outlets to meet any specs and demands..
- Handcrafted in New Jersey
- Base:
  - Bolt down base is all welded one piece construction (103008-43-MT)
  - Metal Column: 3" dia., 16 gauge steel
  - Weight: 12.5 lbs
  - Finish: Black Wrinkle
- Dimensions:
  - Length: 84"
  - Width: 20"
  - Height: 43"
  - Table Top Thickness: 6"



Finish:  
 Wilsonart Antique Bourbon Pine 8215



**Laminate:**  
Wilsonart Anitque Bourbon Pine

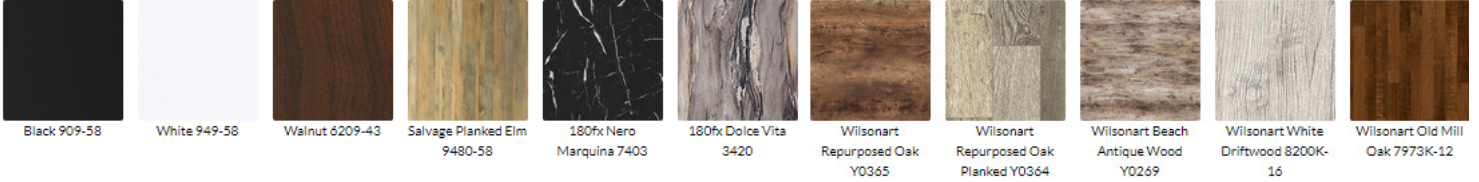

## Model: JMS-TT-42-103008-43MT

- Featured long tables provide space efficiency and encourages socializing and networking when placed in high traffic areas or can be used to accommodate large parties.
- Application: offices, libraries, shop displays, front of house, lobbies, boardrooms, events and trade shows, restaurants and bars
- Laminate features fire resistance Grade 32 / 50. Stain, scratch and impact resistant under normal use conditions. Postform grade of 12 / 20.
- Our table are made from 1.5" thick natural wood frame and high quality industrial grade plywood, which makes this table very sturdy, heavy and ready for high usage environments.
- We can create this communal bar table in any laminate, finish, size and custom own materials. Please contact us for details.
- Optional USB ports and 110v outlets can be installed anywhere on the table. We can customize the ports/outlets to meet any specs and demands.
- Handcrafted in New Jersey
- Base:
  - Bolt down base is all welded one piece construction (103008-43-MT)
  - Metal Column: 3" dia., 16 gauge steel
  - Weight: 12.5 lbs
  - Finish: Black Wrinkle
- Dimensions:
  - Length: 48", 60", 72", 84" or 96"
  - Width: 24"
  - Height: 42"
  - Table Top Thickness: 1.5"

